

BREATHE HEALTHIER[®]
GeneralAire[®]

**PRODUCT & PRICE
CATALOGUE
2026**

VALID FROM MARCH 1ST 2026 - FEBRUARY 28TH 2027

DISCLAIMER

**CGF reserves the right to change pricing at anytime.
Due to political and economical instability, pricing could be affected at anytime.**

PRODUCT TOWER CO-OP PROGRAM

Introducing our brand new GeneralAire Product Tower, showcasing our top IAQ products including humidifiers, dehumidifiers, and air cleaners.

Products Included:

- GF4400A Fan Assisted Humidifier
- GF3200DMM Bypass Humidifier
- GF3200PFT Pulse Flow Through Humidifier
- GFMAC1400-11 Air Cleaner
- GF1625-11 Air Cleaner
- DH75 Dehumidifier
- GFX5 Digital Wi-Fi Humidistat
- GFMHX3 Manual Humidistat

PART NUMBER: TOWERDISPLAY



SIDE A



SIDE B



FRONT B

CONTACT US



sales@generalaire.ca



(416) 757-3691

1	HUMIDIFIERS	
	All Humidifiers Quicklook	1-2
	Vapor Pads	3
	Accessories	4
	GF4400A	5
	GF3200DMM/DMD	6
	GF4200DMM/DMD	7
	GF1042DMM/DMD	8
	GF5500	9
	DSRDAH	10
	GF3200PFT	11
	GF4200PFT	12
	GF1099LHS	13
	GF1137L	14
	Legacy Elite Steam Parts	15
2	DEHUMIDIFIERS	
	Dehumidifiers	16
3	AIR CLEANERS	
	MAC & GeneralAire Air Cleaners	17
	HEPA, TERSUS & AC Models	18
4	SECONDWIND	
	Residential Air Purifiers	19
	Commercial Air Purifiers	20
5	GENERAL & GARBER OIL FILTERS	
	General Oil Filters	21
	General Oil Accessories	22
	Garber Oil Filters	23
6	TJERNLUND	
	Specific Parts Quicklook	24-25
	In-Line Inducers	26-27
	Side Wall Vent Systems	28-29
	Power Venters	30
	Commercial Power Venters	31
	Duct Boosters	32
	Combustion Equipment & Accessory Control	33
7	MASTERCRAFT	
	Sootmasters	34
	More Sootmasters Parts	35
8	SUPERIOR	
	Smoke Generators	36



Confidential Distributors List Prices

HUMIDIFIERS



GF4400A FAN ASSIST HUMIDIFIER

The 4400A uses a very quiet cross-flow fan rated at 48dB, a 25% reduction in noise versus the rotary blade 1000. Uses "1/2" Push-On Valve with Shutoff in Place of Saddle Valve.



Product Code	Description	Standard Package	Standard Weight (KG)
GF4400A	Fan-Assist Evaporative Humidifier	1	4.53
GFGA35	Replacement Vapor Pad	1	0.5



GF3200 EVAPORATIVE HUMIDIFIER

Flow through humidifier with MXH3 or GFX5 stat. Designed for lower plenum temperatures, fits tight spaces, new stainless steel water supply tube, smaller low profile cover, left or right by pass installation, water supply tubing for hot or cold water.

Product Code	Description	Standard Package	Standard Weight (KG)
GF3200DMM	Deluxe Flow Thru Humidifier w/ MXH3 Manual Humidistat	1	7
GF3200DMD	Deluxe Flow Thru Humidifier w/ GFX4 Digital Humidistat	1	7
GFGA10	Replacement Vapor Pad	1	0.5



GF4200 EVAPORATIVE HUMIDIFIER

Flow through humidifier with MXH3 or GFX5 stat. Designed for lower plenum temperatures, fits tight spaces, new stainless steel water supply tube, smaller low profile cover, left or right by pass installation, water supply tubing for hot or cold water.

Product Code	Description	Standard Package	Standard Weight (KG)
GF4200DMM	Deluxe Flow Thru Humidifier w/ MXH3 Manual Humidistat	1	8
GF4200DMD	Deluxe Flow Thru Humidifier w/ GFX4 Digital Humidistat	1	8
GFGA35	Replacement Vapor Pad	1	0.5



GF1042 EVAPORATIVE HUMIDIFIER

Flow through bypass humidifier with patented water distribution system. Includes integral bypass damper, wall/duct humidistat, 24v transformer, 6" plenum collar, 15' drain hose, and brass fittings. The Deluxe includes a cold water installation kit.



Product Code	Description	Standard Package	Standard Weight (KG)
GF1042DMM	Deluxe Flow Thru Humidifier w/ MXH3 Manual Humidistat	1	6.2
GF1042DMD	Deluxe Flow Thru Humidifier w/ GFX4 Digital Humidistat	1	6.2
GF990-13	Replacement Vapor Pad	1	1.0



GF1099LHS EVAPORATIVE HUMIDIFIER

Flow thru by pass drain type humidifier with patented Kinetic Flo® through water distribution system for maximum evaporative performance. Humidity control damper standard with 7" installation ring, solenoid valve, transformer and MXH3 humidistat

Product Code	Description	Standard Package	Standard Weight (KG)
GF1099LHS	Flow Through Bypass Humidifier w/MXH3 Manual Humidistat	1	8.6
GFGA23	Replacement Vapor Pad	1	0.5



GF5500 STEAM HUMIDIFIER

Steam Humidifier with GFX4 stat. Duct mount kit included. Produces up to 28.5 gallons per day.

Product Code	Description	Standard Package	Standard Weight (KG)
GF5500	Steam Humidifier up to 5500 sq. ft.	1	6.81
GF55	Replacement Steam Cylinder	1	1.07



GF1137L FAN POWERED HUMIDIFIER

Drain type fan power humidifier for warm air plenum installations. Built in isolation relay feature provides 24V secondary voltage for control of fan motor. Includes solenoid valve, 110V power cord, 15' of 5/8" dia drain hose, valve & humidistat

Product Code	Description	Standard Package	Standard Weight (KG)
GF1137L	Fan Powered Flow Through Humidifier	1	8.12
GF990-13	Replacement Vapor Pad	1	1.0

Prices shown are based on carton quantities. 5% surcharge for broken cartons.

Our minimum Order Value before H.S.T. is \$250. A surcharge of \$25 on all orders under this minimum will be applied.

For Replacement Parts Only, minimum Order Value before H.S.T. is \$50. All prices are subject to change without notice.

Any incidental charges incurred will be the responsibility of the buyer, incidents include but are not limited to storing fees, docking charges, etc.



Confidential Distributors List Prices

HUMIDIFIERS



DSRDAH ROTARY DISC HUMIDIFIER

The Rotary Disc evaporative disc wheel contains 42 polycarbonate discs creating an unprecedented 15 square feet of surface area. Due to the large contact area between the water and airflow, the Rotary Disc design produces humidity even with room temperature (recirculation) air and is an ideal by-pass humidifier for Heat Pump applications.



Product Code	Description	Standard Package	Standard Weight (KG)
DSRDAH	Rotary Disc Humidifier	1	8.6
DPDS-AF15	Autoflush Kit	1	3.0



GF3200PFT PULSE FLOW THROUGH HUMIDIFIER

Patented electronic water flow control reduces demand for water by up to 88% compared to ordinary flow-through humidifiers. When in operation, the water supply solenoid valve is pulsed on for approximately 4 seconds, sufficient time to soak the entire evaporative pad. Humidifies up to 3200 sq. ft.

Product Code	Description	Standard Package	Standard Weight (KG)
GF3200PFT	Pulse Flow Thru with Patented Controller Humidifier	1	8
DPDS00200	Replacement Vapor Pad	1	0.5
DPHSA220	Solenoid (Water Hammer Assembly)	1	0.5



GF4200PFT PULSE FLOW THROUGH HUMIDIFIER

Patented electronic water flow control reduces demand for water by up to 88% compared to ordinary flow-through humidifiers. When in operation, the water supply solenoid valve is pulsed on for approximately 4 seconds, sufficient time to soak the entire evaporative pad. Humidifies up to 4200 sq. ft.

Product Code	Description	Standard Package	Standard Weight (KG)
GF4200PFT	Pulse Flow Thru with Patented Controller Humidifier	1	8
GFGA900	Replacement Vapor Pad	1	0.5
DPHSA220	Solenoid (Water Hammer Assembly)	1	0.5

Prices shown are based on carton quantities. 5% surcharge for broken cartons.
Our minimum Order Value before H.S.T. is \$250. A surcharge of \$25 on all orders under this minimum will be applied.
For Replacement Parts Only, minimum Order Value before H.S.T. is \$50. All prices are subject to change without notice.
Any incidental charges incurred will be the responsibility of the buyer, incidents include but are not limited to storing fees, docking charges, etc.



Confidential Distributors List Prices

HUMIDIFIER VAPOR PADS



Product Code	Models Fit For	Standard Package
GFGA10	GeneralAire: GF3200DMM & GF3200DMD AprilAire: 110, 220, 500, 500A, 500M, 550, 550A & 558 Honeywell: HE100, HE150, HE220, HE225, HE240, & HE280	1
GFGA12	AprilAire: 112, 136, 224, 440, 445 & 445A	1
GFGA23	GeneralAire: GF1099LHS & 950	1
GFGA35	GeneralAire: GF4200DMM, GF4200DMD & GF4400A AprilAire: 350, 360, 560, 568, 600, 600A, 600M, 700, 700A, 700M, 760, 768 Honeywell: HE260, HE265, HE360, HE365	1
GFGA570	GeneralAire: GF570DMM, GF570DMD & GF570WSC	1
GFGA900 (Previously GFGA19)	GeneralAire: GF900DMM, GF4200PFT, GF1000LHM, GF900WSC & GF1000LHD	1
GF990-13	GeneralAire: GF1040L, GF1042DMM, GF1042DMD, GF1042LH, GF1042WSC, GF1137L & SL16	1
GF1099-20	General Aire: GF1099LH & LHS (For Models Made before August 2008)	1
DPDS00200	GeneralAire: GF3200PFT	1
GF81-15	GeneralAire: Model 81 Skuttle: 90S	1
GF727-12	GeneralAire: Model 747L & 727	1

Prices shown are based on carton quantities. 5% surcharge for broken cartons.
 Our minimum Order Value before H.S.T. is \$250. A surcharge of \$25 on all orders under this minimum will be applied.
 For Replacement Parts Only, minimum Order Value before H.S.T. is \$50. All prices are subject to change without notice.
 Any incidental charges incurred will be the responsibility of the buyer, incidents include but are not limited to storing fees, docking charges, etc.









Confidential Distributors List Prices

HUMIDIFIER ACCESSORIES & REPLACEMENT PARTS





HUMIDISTATS

Image	Product Code	Description	Standard Package
 NEW	GFX5	Digital Wi-Fi Humidistat with Furnace Blower Controller	1
	GFMHX3	Manual Humidistat. Wall or Duct Mount	1
	GFX4-1	Outdoor Sensor for GFX4 & GFX5	1





SOLENOID VALVES

Image	Product Code	Description	Standard Package
	GF4200-05	Solenoid Valve for 3200DMM/4200DMM	1
	GF990-53	Solenoid Valve 24V for models 1042 & 1137. Includes fittings	1
	DPHSA220	Solenoid Valve with Water Hammer for GF-3200PFT & GF-4200PFT	1
	GFGA4040	Solenoid Valve 24V for Elite Series Humidifiers. 1099LHS/570/900 Humidifiers. Also fits Aprilaire models 550, 560,600	1
	GF16-20	Solenoid Valve for SL16	1
	GF109942	Solenoid Valve for Model 1099LH (OLDER MODEL)	1
	GF4400-05	Solenoid Valve for GF4400A	1
	GFGA4045	Solenoid Valve for GF1000LHM	1

ACCESSORIES

Image	Product Code	Description	Standard Package
	GFAP2	Aquapro Digital Water Tester	1
	GF12500	Fan Sensing Switch	1
	GFG98	Indoor Digital Humidity Temperature Gauge. Wall mount or table top positioning	1
	GFG99	Filter Media Indicator (for use with residential & light commercial mechanical filter system)	1

OTHER PARTS

Image	Product Code	Description	Standard Package
	DPDS00325	Quick Connect Tee valve w/Shut Off (Replaces GP81-51SPV Saddle Valve Assembly Self Tapping)	1
	GFGA50 GFGA51	24V Current Sensing Relay / 120V Current Sensing Relay	1
	GP81-45	24V Transformer	1
	GF81-53	Float Valve assembly for Model 65 & 81	1
	GP4200-38	PEX Tubing Kit (For GF3200DMM, GF4200DMM & GF4400A) *Optional for All Other Humidifier Models*	1

Prices shown are based on carton quantities. 5% surcharge for broken cartons.
Our minimum Order Value before H.S.T. is \$250. A surcharge of \$25 on all orders under this minimum will be applied.
For Replacement Parts Only, minimum Order Value before H.S.T. is \$50. All prices are subject to change without notice.
Any incidental charges incurred will be the responsibility of the buyer, incidents include but are not limited to storing fees, docking charges, etc.

Confidential Distributors List Prices

GF4400A FAN ASSIST HUMIDIFIER

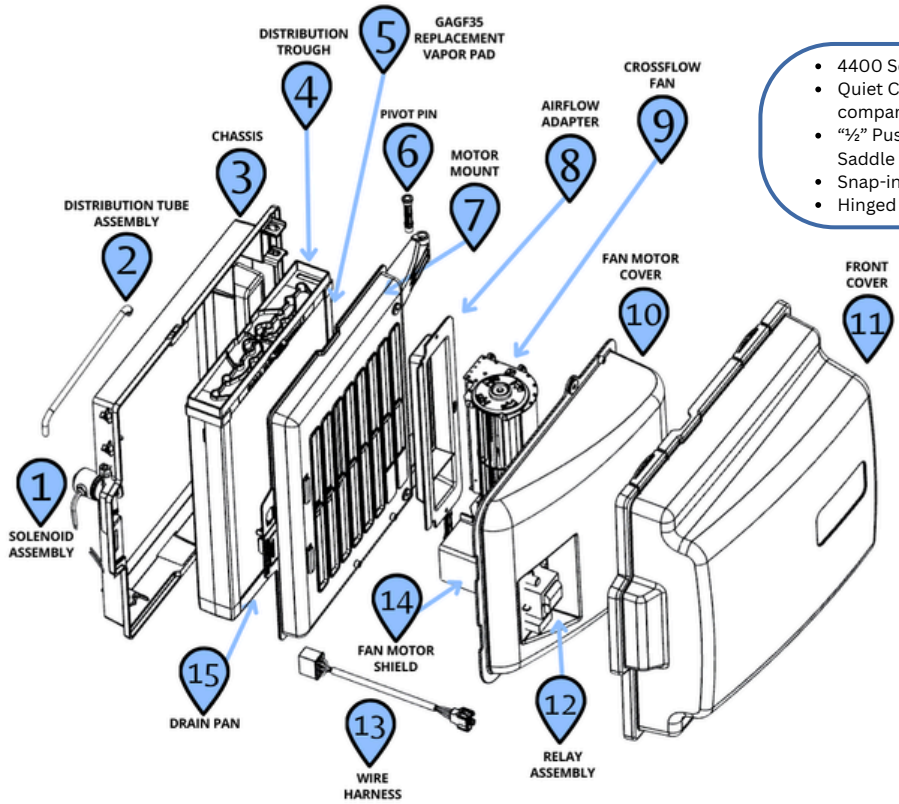

- 4400 Square Foot Coverage, 19 GPD
- Quiet Cross-Flow Fan, Low Decibel Sound compared to Axial Fan
- "½" Push-On Valve with Shutoff in Place of Saddle Valve
- Snap-in-Place, Easy-Lift-Off Cover
- Hinged Door

Diagram Number	Product Code	Description	Standard Package
N/A	GF4400A	Fan-Assist Evaporative Humidifier	1
1	GF4400-05	Solenoid Valve	1
2	GF4200-21	Distribution Tube Assembly	1
3	GF4400-01	Chassis	1
4	GF4200-15	Distribution Trough	1
5	GFGA35	Replacement Vapor Pad	1
6	GP4400-22	Pivot Pin	1
7	GF4400-09	Motor Mount	1
8	GF4400-08	Air Flow Adapter	1
9	GF4400-06	Crossflow Fan	1
10	GF4400-07	Fan Motor Cover	1
11	GF4400-13	Front Cover	1
12	GF1137-61	Relay Assembly	1
13	GF4400-11	Wire Harness	1
14	GF4400-12	Fan Motor Shield	1
15	GF4200-14	Drain Pan	1
Not Shown	GF4200-10	Spout	1
Not Shown	GFX5	Digital Wi-Fi Humidistat with Furnace Blower Controller	1
Not Shown	DPDS00325	Quick Connect Tee valve w/Shut Off <small>(Replaces GP81-51SPV Saddle Valve Assembly Self Tapping)</small>	1
Not Shown	GP4200-38	PEX Tubing Kit <small>(For GF3200DMM, GF4200DMM & GF4400A) *Optional for All Other Humidifier Models*</small>	1

Prices shown are based on carton quantities. 5% surcharge for broken cartons.
 Our minimum Order Value before H.S.T. is \$250. A surcharge of \$25 on all orders under this minimum will be applied.
 For Replacement Parts Only, minimum Order Value before H.S.T. is \$50. All prices are subject to change without notice.
 Any incidental charges incurred will be the responsibility of the buyer, incidents include but are not limited to storing fees, docking charges, etc.

Confidential Distributors List Prices

GF3200DMM/DMD EVAPORATIVE HUMIDIFIER

- 3200 Square Foot Coverage, 12 GPD
- New Distributor Trough Design Distributes Water Evenly Over Pad
- Models include ½" OD, PEX water supply tubing (hi-temp and hi pressure) for hot or cold water installs. Eliminating the need for use of copper piping
- Low-Profile Cover Forces Air Through Vapor Pad at it's Warmest Point
- Snap-in-Place, Easy-Lift-Off Cover

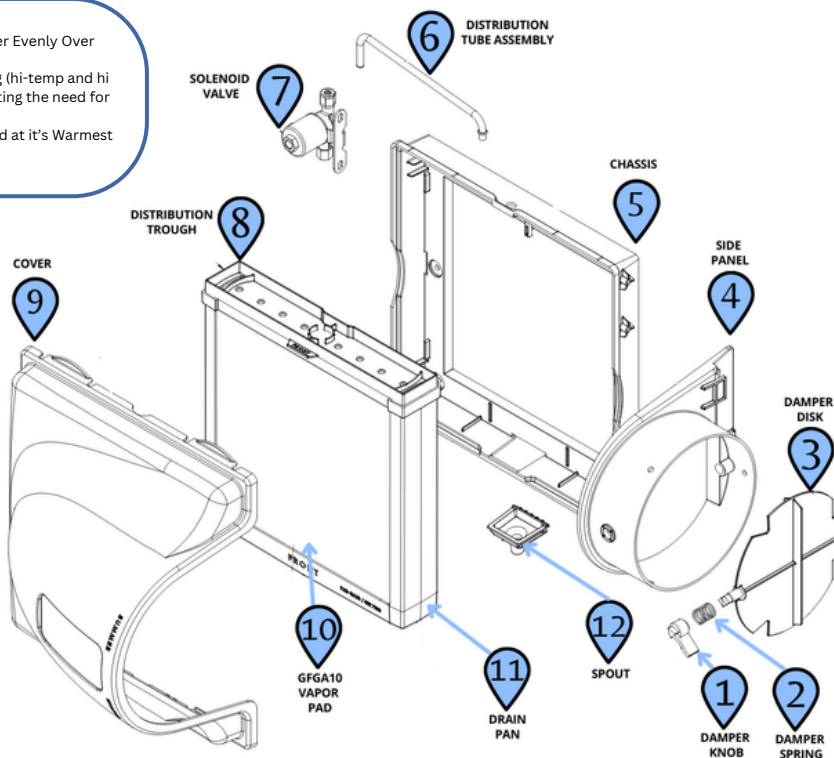

Diagram Number	Product Code	Description	Standard Package
N/A	GF3200DMM	Deluxe Flow Thru Humidifier w/ MHX3 Manual Humidistat	1
N/A	GF3200DMD	Deluxe Flow Thru Humidifier w/ GFX4 Digital Humidistat	1
1	GF900-11	Damper Knob	1
2	GF900-29	Damper Spring	1
3	GF900-28	Damper Disk	1
4	GF4200-02	Side Panel	1
5	GF3200-01	Chassis	1
6	GF4200-21	Distribution Tube Assembly	1
7	GF4200-05	Solenoid Valve	1
8	GF4200-15	NEW Distribution Trough	1
9	GF3200-13	Cover	1
10	GFGA10	Replacement Vapor Pad (Formally 3200-12)	1
11	GF3200-14	Drain Pan	1
12	GF4200-10	Spout	1
Not Shown	GFX5	Digital Wi-Fi Humidistat with Furnace Blower Controller	1
Not Shown	GFMHX3	Manual Humidistat Wall or Duct Mount	1
Not Shown	GFP101	Compression Nut	1
Not Shown	GFP102	Compression Sleeve	1
Not Shown	GP4200-38	PEX Tubing Kit (For GF3200DMM, GF4200DMM & GF4400A) *Optional for All Other Humidifier Models*	1
Not Shown	DPDS00325	Quick Connect Tee valve w/Shut Off (Replaces GP81-51SPV Saddle Valve Assembly Self Tapping)	1

Prices shown are based on carton quantities. 5% surcharge for broken cartons.
 Our minimum Order Value before H.S.T. is \$250. A surcharge of \$25 on all orders under this minimum will be applied.
 For Replacement Parts Only, minimum Order Value before H.S.T. is \$50. All prices are subject to change without notice.
 Any incidental charges incurred will be the responsibility of the buyer, incidents include but are not limited to storing fees, docking charges, etc.

Confidential Distributors List Prices

GF4200DMM/DMD EVAPORATIVE HUMIDIFIER

- 4200 Square Foot Coverage, 17 GPD
- New Distributor Trough Design Distributes Water Evenly Over Pad
- Models include 1/2" OD, PEX water supply tubing (hi-temp and hi pressure) for hot or cold water installs. Eliminating the need for use of copper piping
- Low-Profile Cover Forces Air Through Vapor Pad at it's Warmest Point
- Snap-in-Place, Easy-Lift-Off Cover

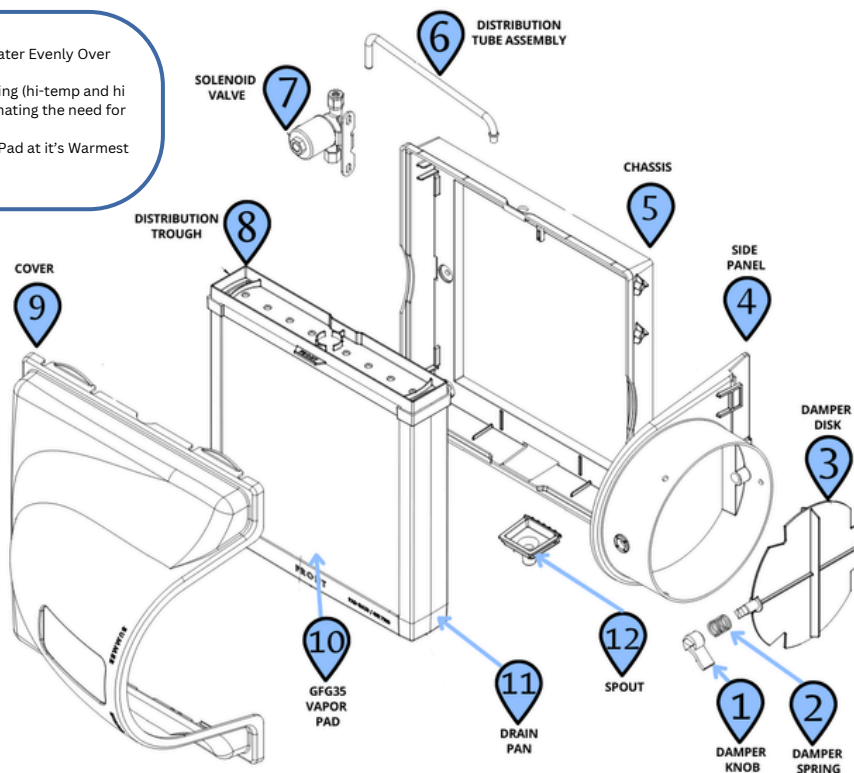

Diagram Number	Product Code	Description	Standard Package
N/A	GF4200DMM	Deluxe Flow Thru Humidifier w/ MXH3 Manual Humidistat	1
N/A	GF4200DMD	Deluxe Flow Thru Humidifier w/ GFX4 Digital Humidistat	1
1	GF900-11	Damper Knob	1
2	GF900-29	Damper Spring	1
3	GF900-28	Damper Disk	1
4	GF4200-02	Side Panel	1
5	GF4200-01	Chassis	1
6	GF4200-21	Distribution Tube Assembly	1
7	GF4200-05	Solenoid Valve	1
8	GF4200-15	NEW Distribution Trough	1
9	GF4200-13	Cover	1
10	GFGA35	Replacement Vapor Pad (Formally 4200-12)	1
11	GF3200-14	Drain Pan	1
12	GF4200-10	Spout	1
Not Shown	GFX5	Digital Wi-Fi Humidistat with Furnace Blower Controller	1
Not Shown	GFMHX3	Manual Humidistat Wall or Duct Mount	1
Not Shown	GFP101	Compression Nut	1
Not Shown	GFP102	Compression Sleeve	1
Not Shown	GP4200-38	PEX Tubing Kit (For GF3200DMM, GF4200DMM & GF4400A) *Optional for All Other Humidifier Models*	1
Not Shown	DPDS00325	Quick Connect Tee valve w/Shut Off (Replaces GP81-51SPV Saddle Valve Assembly Self Tapping)	1

Prices shown are based on carton quantities. 5% surcharge for broken cartons.
 Our minimum Order Value before H.S.T. is \$250. A surcharge of \$25 on all orders under this minimum will be applied.
 For Replacement Parts Only, minimum Order Value before H.S.T. is \$50. All prices are subject to change without notice.
 Any incidental charges incurred will be the responsibility of the buyer, incidents include but are not limited to storing fees, docking charges, etc.

Confidential Distributors List Prices

GF1042DMM/DMD EVAPORATIVE HUMIDIFIER

- 2800 Square Foot Coverage, 17 GPD
- 2' Flexible Bypass Duct
- Quick Tee Connect Valve w/ Shut Off replacing Old Saddle Valve
- Optional Narrow Duct Adapter Plate
- 10' Water Supply Tubing, 10' Low Voltage Wire

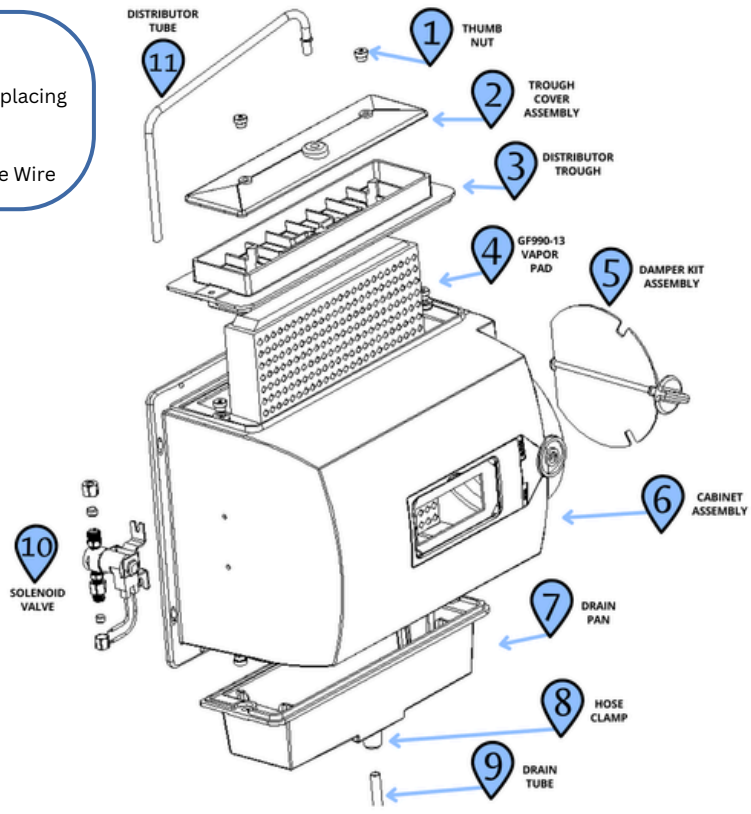

DIAGRAM LIST

PARTS NOT SHOWN

Diagram Number	Product Code	Description	Standard Package
N/A	GF1042DMM	Model 1042DMM w/ MHX3 Humidistat	1
N/A	GF1042DMD	Model 1042DMD w/ GFX4 Humidistat	1
1	GP1099-9	Thumb Nut	8
2	GF1137-35	Trough Cover Assembly	1
3	GF1137-4	Distributor Trough	1
4	GF990-13	Replacement Vapor Pad	1
5	GF1042-3	Damper Kit Assembly (Damper/Spring/Knob/Hardware)	1
6	GF104216	Cabinet Assembly 24V	1
7	GF1137-3	Drain Pan	1
8	GPP163	Hose Clamp for Drain Tube	1
9	GP1099-16	Drain Tube (15' of 5/8" ID)	1
10	GF990-53	Solenoid Valve 24V (Includes Fittings)	1
11	GF10425	Distributor Tube	1
Not Shown	GFX5	Digital Wi-Fi Humidistat with Furnace Blower Controller	1
Not Shown	GFMHX3	Manual Humidistat Wall or Duct Mount	1
Not Shown	DPDS00325	Quick Connect Tee valve w/Shut Off (Replaces GP81-51SPV Saddle Valve Assembly Self Tapping)	1

Product Code	Description	Standard Package
GPP103	Compression Nut	1
GPP104	Compression Sleeve	1
GPP111	Connector Only	1
GF9903776	Orifice & Strainer Assembly (Standard Water Pressure: 40PSI-120PSI)	1
GF9903775	Orifice & Strainer Assembly (Standard Water Pressure: 20PSI-40PSI)	1
GP81-45	Transformer 24V	1
GP81-60	10' Poly Water Supply Kit	1
GP81-57	6" Flexible Bypass w/ Collar	1
GP1040AD	Humidifier Mounting/Adapter Plate	1
GP1040-13	Metal Plenum Ring	1
GF1042-20	Install Kit (Bypass Rings & Water Tubing Kit)	1
GF1042-80	Parts Bag (Solenoid, Thumb Nuts & Metal Screws)	1

Prices shown are based on carton quantities. 5% surcharge for broken cartons. Our minimum Order Value before H.S.T. is \$250. A surcharge of \$25 on all orders under this minimum will be applied. For Replacement Parts Only, minimum Order Value before H.S.T. is \$50. All prices are subject to change without notice. Any incidental charges incurred will be the responsibility of the buyer, incidents include but are not limited to storing fees, docking charges, etc.

Confidential Distributors List Prices **GF5500 STEAM HUMIDIFIER**

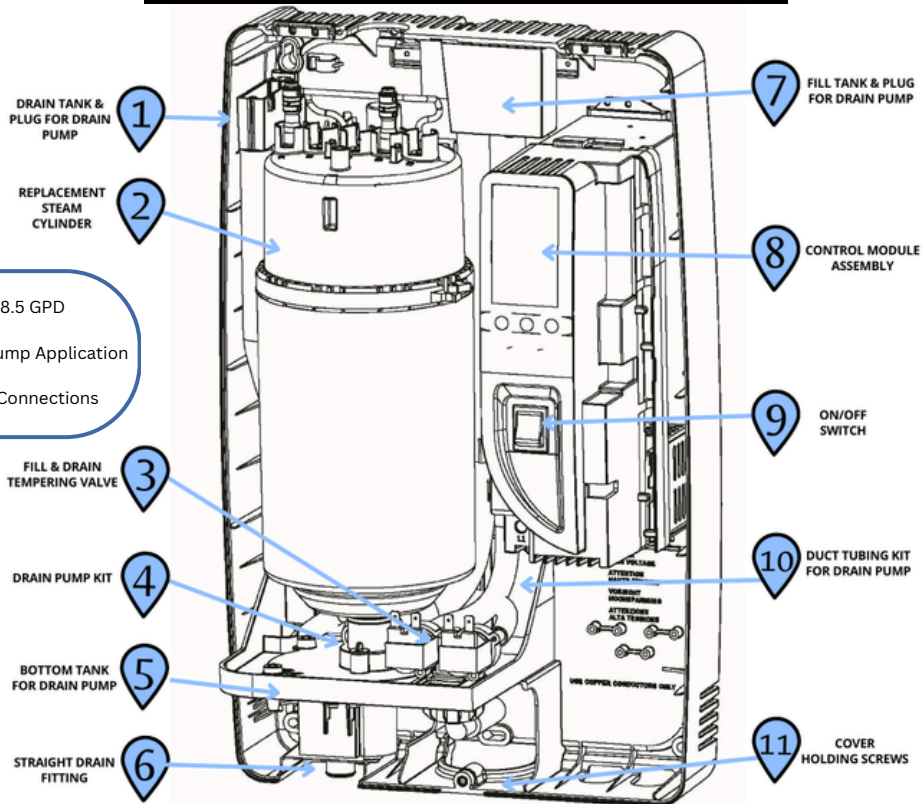

- 5500 Square Foot Coverage, 28.5 GPD
- Automatic Digital Control
- Suitable for Low-temp Heat Pump Application
- 1 Screw Cover Release
- "Snap in Place" Cylinder Wire Connections

Diagram Number	Product Code	Description	Standard Package
1	GF25-8	Drain Tank & Plug for Drain Pump	1
2	GF55	Replacement Steam Cylinder	1
3	GF5500-08	Fill & Drain Tempering Valve/Solenoid 230V	1
4	GF25-7	Drain Pump Kit	1
5	GF25-6	Bottom Tank for Drain Pump	1
6	GF5500-06	Straight Drain Fitting	1
7	GF25-2	Fill Tank & Plug for Drain Pump	1
8	GF5500-03	Control Module Assembly 115V/230V	1
9	GF35-18	On/Off Switch	1
10	GF25-5	Duct Tubing Kit for Drain Pump	1
11	GF35-25	Cover Holding Screws (For CH Series)	1
Not Shown	GFCHK7513002	7/8" ID Steam House (Min: 6') (Formerly GF-20:2)	1
Not Shown	GF5500-04	Internal Wire Kit	1
Not Shown	GF5500-05	3/4" ID Drain Hose (Pre-Cut of 10')	1
Not Shown	GF5500-01	Mounting Straps	1
Not Shown	GF5500-07	8" Steam Manifold	1
Not Shown	DPDS00325	1/2" Quick Connect Tee valve w/Shut Off	1
Not Shown	GFX5	Digital Wi-Fi Humidistat with Furnace Blower Controller	1
Not Shown	GFRMB15R	Remote Blower for 110V (For GF5500 & DS15PBU)	1
Not Shown	GFRMB35R	Remote Blower for 230V (For GF5500, DS25PBU & DS25LCBU)	1
Not Shown	GF5500-09	Steam Trap Kit	1

Prices shown are based on carton quantities. 5% surcharge for broken cartons.
Our minimum Order Value before H.S.T. is \$250. A surcharge of \$25 on all orders under this minimum will be applied.
For Replacement Parts Only, minimum Order Value before H.S.T. is \$50. All prices are subject to change without notice.
Any incidental charges incurred will be the responsibility of the buyer, incidents include but are not limited to storing fees, docking charges, etc.

Confidential Distributors List Prices

DSRDAH ROTARY DISC HUMIDIFIER

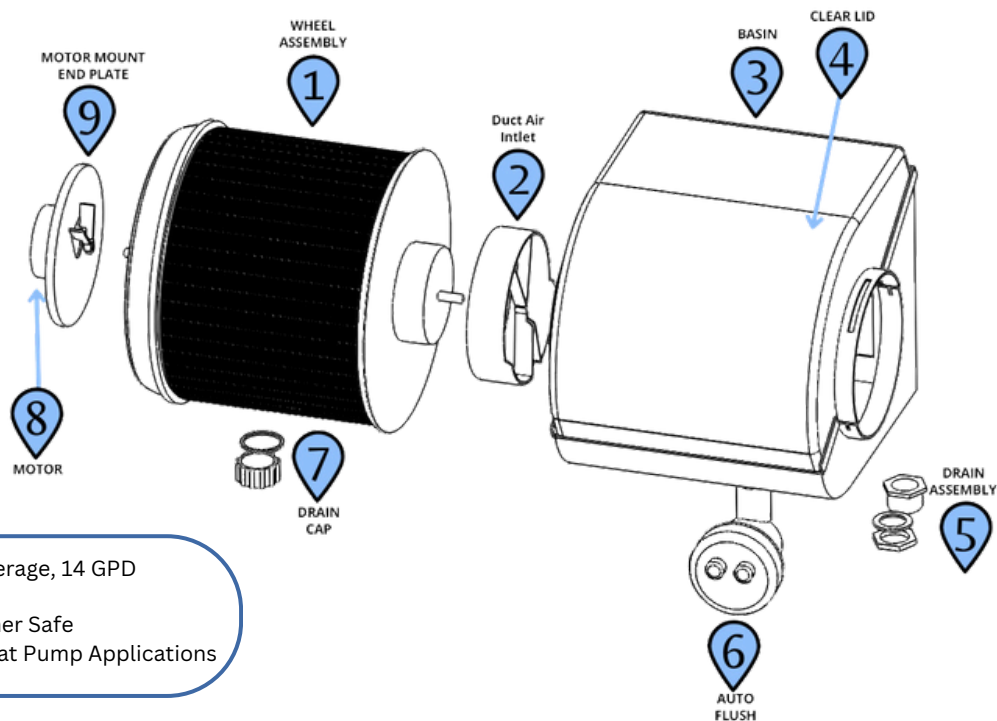

- 3200 Square Foot Coverage, 14 GPD
- No Vapor Pad Needed
- Disc Wheel is Dishwasher Safe
- Ideal Humidifier for Heat Pump Applications

Diagram Number	Product Code	Description	Standard Package
N/A	DSRDAH	Rotary Disc Humidifier	1
1	DPDS-WA	Wheel Assembly	1
2	DPDS00025-000	Duct Air Inlet	1
3	DPDS00004-000	Basin	1
4	DPDS00027-000	Clear Lid	1
5	DPDS00013-000	Drain Assembly	1
6	DPYL21039	Auto Flush (Stand Alone)	1
7	DPDS00009-000	Drain Cap with Washer	1
8	DPDS00091-005	Motor	1
9	DPDS00030-000	Motor Mount End Plate	1
Not Shown	DPDS00115	Motor Kit	1
Not Shown	DPDS-AF15	Auto Flush Kit	1
Not Shown	DPHHD030	Saddle Valve Assembly	1
Not Shown	DPDS00019-000	Float Valve	1
Not Shown	DPDS00046-000	24V/110V Plug-In Transformer	1
Not Shown	DPHEC020	24V/110V Hardwire Transformer	1
Not Shown	DPDS-BP	Bypass Kit	1
Not Shown	DPDS-WK	Water Connection Kit	1
Not Shown	DPDS00080	Current Sensor Relay	1
Not Shown	DPDS-OF	Overflow Kit	1
Not Shown	DPDS00206	Duct Collar with Damper	1
Not Shown	DPDS00021-000	Hanger Plate	1
Not Shown	DPDS-AX	Axle Assembly with Speed Clip	1

Prices shown are based on carton quantities. 5% surcharge for broken cartons.
 Our minimum Order Value before H.S.T. is \$250. A surcharge of \$25 on all orders under this minimum will be applied.
 For Replacement Parts Only, minimum Order Value before H.S.T. is \$50. All prices are subject to change without notice.
 Any incidental charges incurred will be the responsibility of the buyer, incidents include but are not limited to storing fees, docking charges, etc.

Confidential Distributors List Prices

GF3200PFT PULSE FLOW THROUGH HUMIDIFIER

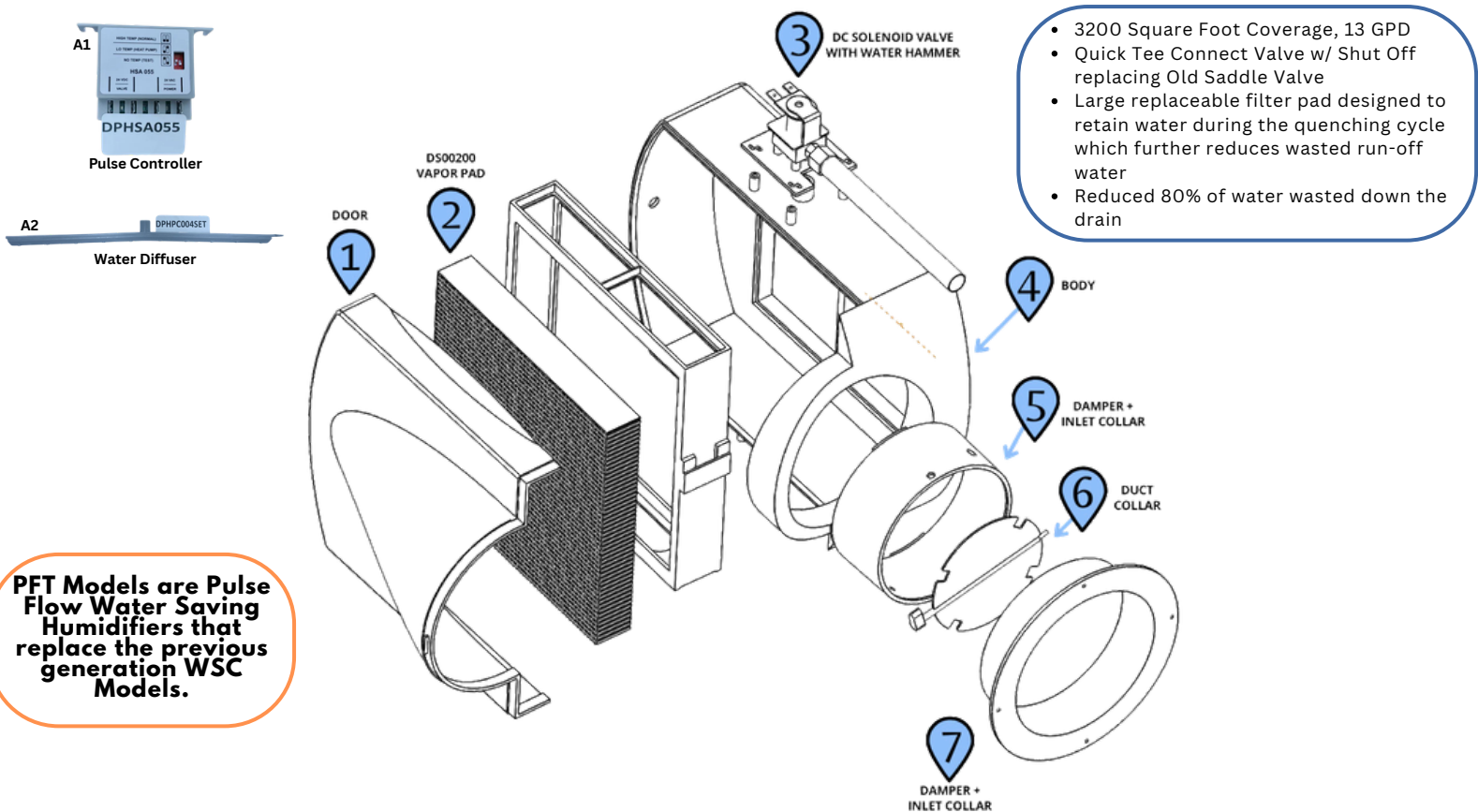

Diagram Number	Product Code	Description	Standard Package
N/A	GF3200PFT	Pulse Flow Thru with Patented Controller Humidifier	1
1	DPHPC008	Door	1
2	DPDS00200	Replacement Vapor Pad	1
3	DPHSA220	DC Solenoid Valve with Water Hammer	1
4	DPHPC006SET	Body	1
5	DPHPC002-012	Damper + Inlet Collar (Same as #7)	1
6	DPHPC020	Duct Collar	1
7	DPHPC002-012	Damper + Inlet Collar (Same as #5)	1
A1	DPHSA055	Pulse Flow Controller with Dip Switch	1
A2	DPHPC004SET	Water Diffuser	1
Not Shown	DPHEC020	Hardwire Transformer 115V/24V	1
Not Shown	DPDS00325	1/2" Quick Connect Tee Valve w/Shut Off	1
Not Shown	GFMHX3	Manual Humidistat Wall or Duct Mount	1
Not Shown	GP81-60	Water Supply Tubing Kit	1

Prices shown are based on carton quantities. 5% surcharge for broken cartons.
 Our minimum Order Value before H.S.T. is \$250. A surcharge of \$25 on all orders under this minimum will be applied.
 For Replacement Parts Only, minimum Order Value before H.S.T. is \$50. All prices are subject to change without notice.
 Any incidental charges incurred will be the responsibility of the buyer, incidents include but are not limited to storing fees, docking charges, etc.

Confidential Distributors List Prices

GF4200PFT PULSE FLOW THROUGH HUMIDIFIER

- 4200 Square Foot Coverage, 18 GPD
- Quick Tee Connect Valve w/ Shut Off replacing Old Saddle Valve
- Large replaceable filter pad designed to retain water during the quenching cycle which further reduces wasted run-off water
- Universal mounting
- Reduced 80% of water wasted down the drain

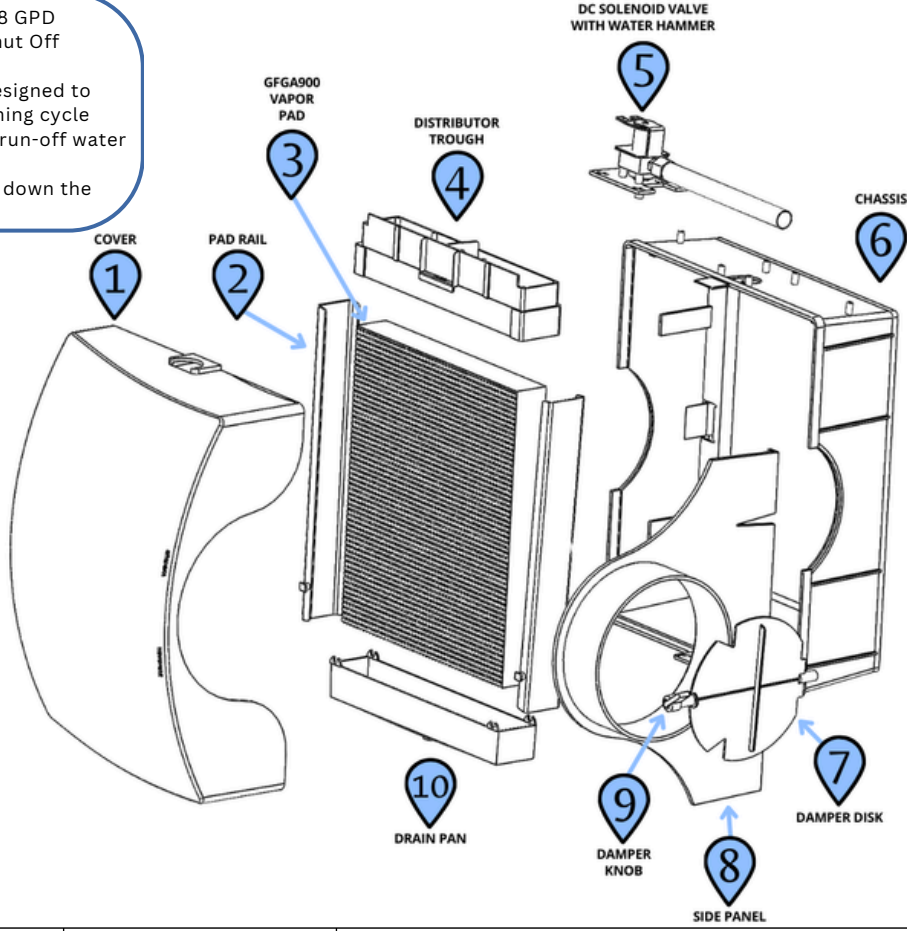

PFT Models are Pulse Flow Water Saving Humidifiers that replace the previous generation WSC Models.

Diagram Number	Product Code	Description	Standard Package
N/A	GF4200PFT	Pulse Flow Thru with Patented Controller Humidifier	1
1	GF900-13	Cover	1
2	GF900-40	Pad Rail	1
3	GFGA900	Replacement Vapor Pad	1
4	GF4200PFTDISTRGH	NEW Distributor Trough	1
5	DPHSA220	DC Solenoid Valve with Water Hammer	1
6	GF900-1	Chassis	1
7	GF900-28	Damper Disk	1
8	GF900-2	Side Panel	1
9	GF900-11	Damper Knob	1
10	GF900-14	Drain Pan	1
A1	DPHSA055	Pulse Flow Controller with Dip Switch	1
A2	DPHPC004SET	Water Diffuser	1
Not Shown	DPHEC020	Hardwire Transformer 115V/24V	1
Not Shown	DPDS00325	1/2" Quick Connect Tee Valve w/Shut Off	1
Not Shown	GFMHX3	Manual Humidistat Wall or Duct Mount	1
Not Shown	GP81-60	Water Supply Tubing Kit	1

Prices shown are based on carton quantities. 5% surcharge for broken cartons.
 Our minimum Order Value before H.S.T. is \$250. A surcharge of \$25 on all orders under this minimum will be applied.
 For Replacement Parts Only, minimum Order Value before H.S.T. is \$50. All prices are subject to change without notice.
 Any incidental charges incurred will be the responsibility of the buyer, incidents include but are not limited to storing fees, docking charges, etc.

Confidential Distributors List Prices

GF1099LHS EVAPORATIVE HUMIDIFIER

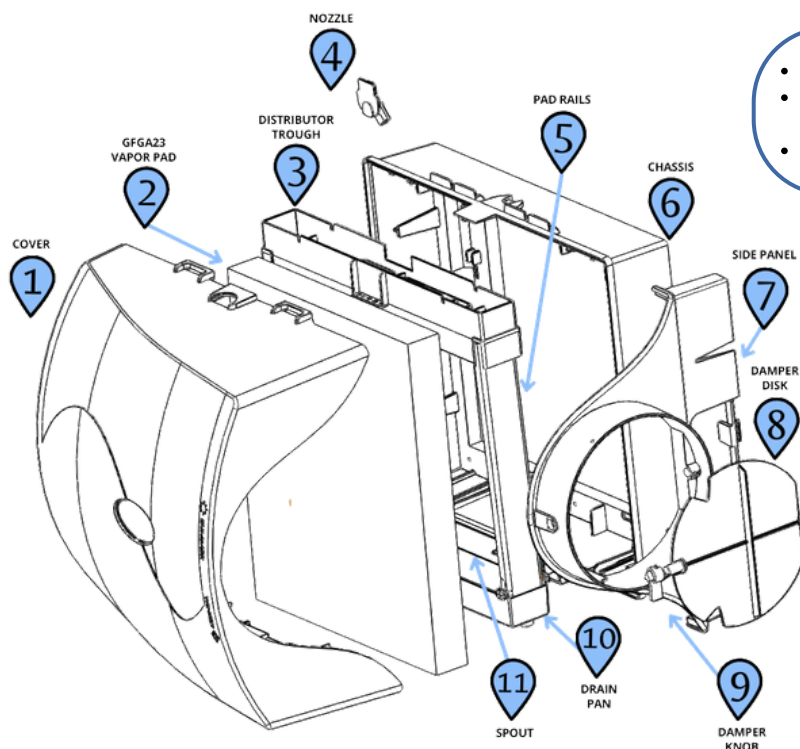

- 3000 Square Foot Coverage, 19 GPD
- Quick Tee Connect Valve w/ Shut Off replacing Old Saddle Valve
- Manual Humidistat

DIAGRAM LIST

PARTS NOT SHOWN

Diagram Number	Product Code	Description	Standard Package
N/A	GF1099LHS	Flow Through Bypass Humidifier w/MHX3 Manual Humidistat	1
1	GF950-13	Cover	1
2	GFGA23	Replacement Vapor Pad	1
3	GF950-15	Distributor Trough	1
4	GF900-9	Nozzle	1
5	GF900-40	Pad Rails	2
6	GF950-1	Chassis	1
7	GF950-2	Side Panel	1
8	GF950-5	Damper Disk	1
9	GF900-11	Damper Knob	1
10	GF950-14	Drain Pan	1
11	GF900-10	Spout	1
Not Shown	GFMHX3	Manual Humidistat	1
Not Shown	GFX5	Digital Wi-Fi Humidistat with Furnace Blower Controller	1

Product Code	Description	Standard Package
GFGA4235	Distributor Tube	1
GFGA4040	Solenoid Valve	1
GFGA4004	Strainer Screen	1
GFP102	Compression Sleeve (Copper)	1
GFP101	Compression Nut	2
GP81-29	Brass Insert Tube	1
GFGA4299	Orifice (Orange)	1
GP81-30	Compression Sleeve (Plastic)	1
GP81-60	Tubing Kit	1
GP81-45	Transformer	1
DPDS00325	Quick Connect Tee valve w/Shut Off <small>(Replaces GP81-51SPV Saddle Valve Assembly Self Tapping)</small>	1
GF1099-20	Old Replacement Vapor Pad <small>(Fits LH & LHS Models)</small>	1
GF109942	Old Solenoid Valve <small>(For Models Made Before August 2008)</small>	1
GF900-29	Damper Spring	1
GF9903776	Orifice/Strainer Assembly Standard	1
GF9903775	Orifice/Assembly Low	1

Prices shown are based on carton quantities. 5% surcharge for broken cartons.
 Our minimum Order Value before H.S.T. is \$250. A surcharge of \$25 on all orders under this minimum will be applied.
 For Replacement Parts Only, minimum Order Value before H.S.T. is \$50. All prices are subject to change without notice.
 Any incidental charges incurred will be the responsibility of the buyer, incidents include but are not limited to storing fees, docking charges, etc.

Confidential Distributors List Prices

GF1137L FAN POWERED HUMIDIFIER

- 3000 Square Foot Coverage, 18 GPD
- Easily Mounts on Warm Air Plenum
- Quiet Operation
- Cover is Made with UV Stable Automotive Grade Plastic for Long Lasting Durability

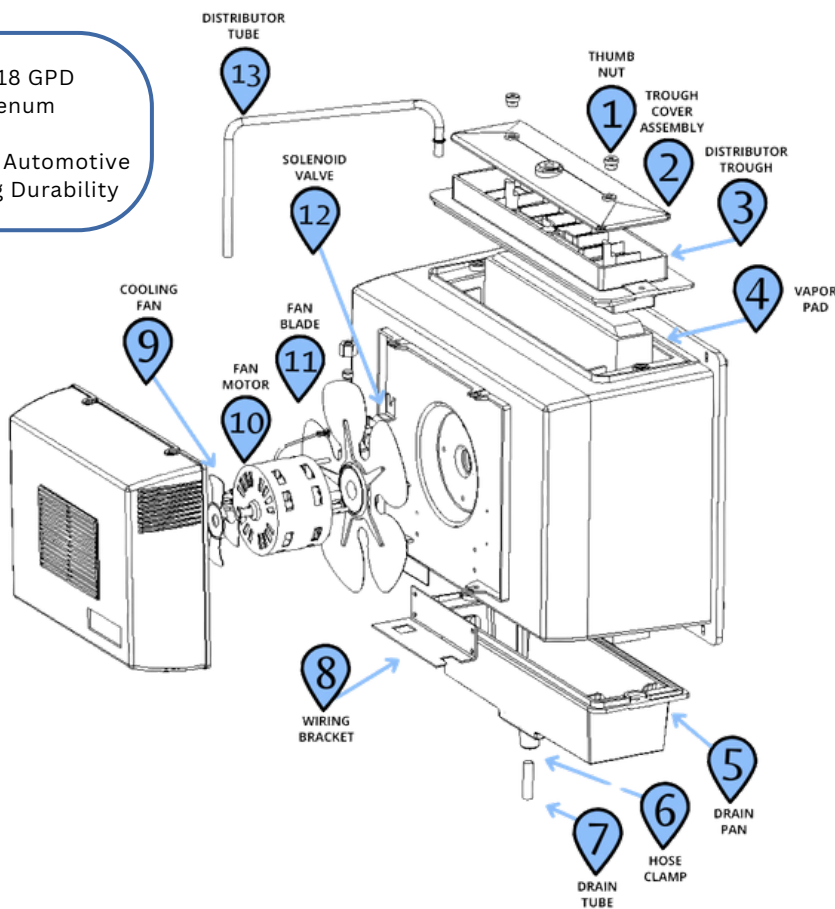

DIAGRAM LIST

PARTS NOT SHOWN

Diagram Number	Product Code	Description	Standard Package
N/A	GF1137L	Fan Powered Flow Through Humidifier	1
1	GP1099-9	Thumb Nut	6
2	GF1137-05	Trough Cover Assembly	1
3	GF1137-4	Distributor Trough	1
4	GF990-13	Replacement Vapor Pad	1
5	GF1137-3	Drain Pan	1
6	GPP163	Hose Clamp	1
7	GP1099-16	Drain Tube (15' 5/8" 1D)	1
8	GF1137-7	Wiring Bracket	1
9	GF1137-50	Cooling Fan	1
10	GF1137-8	Fan Motor	1
11	GF1137-9	Fan Blade	1
12	GF990-53	Solenoid Valve	1
13	GF1137-24	Distributor Tube	1
Not Shown	GMHX3	Manual Humidistat Wall or Duct Mount	1
Not Shown	GF5	Digital Wi-Fi Humidistat with Furnace Blower Controller	1

Product Code	Description	Standard Package
GFGA4238	Relay Assembly	1
GF1137-49	Fan Motor Grommet	4
GFP103	Compression Nut	1
GPP104	Compression Sleeve	1
GPP111	Connector Only	1
GF1137-20	Fan Guard	1
GF1137-2	Fan Shroud	1
GF1137-38	Cabinet Assembly	1
GF9903776	Orifice & Strainer Assembly (Standard Water Pressure: 40PSI-120PSI)	1
GF9903775	Orifice & Strainer Assembly (Standard Water Pressure: 20PSI-40PSI)	1
GF1137-15	Mounting Stud	4
GF1137-31	Power Supply Cord	1
GF1137-39	Front Cover Assembly	1
GF1137-17	Old Solenoid Valve (Use For Models Purchased before July 2006)	1

Prices shown are based on carton quantities. 5% surcharge for broken cartons.
 Our minimum Order Value before H.S.T. is \$250. A surcharge of \$25 on all orders under this minimum will be applied.
 For Replacement Parts Only, minimum Order Value before H.S.T. is \$50. All prices are subject to change without notice.
 Any incidental charges incurred will be the responsibility of the buyer, incidents include but are not limited to storing fees, docking charges, etc.



Confidential Distributors List Prices

LEGACY ELITE STEAM PARTS

STEAM CYLINDERS

Product Code	Description
GF15-14	Replacement Steam Cylinder for DS15
GF35-14	Replacement Steam Cylinder for DS35/RS35
GF35-15	Replacement Low Conductivity Cylinder for DS35/RS35
GF50-14	Replacement Steam Cylinder for DS50
GF50-15	Replacement Low Conductivity Cylinder for DS50

OTHER PARTS

Product Code	Description
GF20-4	Water Line Connector (For DS15P, DS2SP, DS25LC, RS15P & RS25P)
GF7531-15-50	90° Drain Adapter w/ Barbed Fitting (For DS15P, DS2SP, DS25LC, RS15P & RS25P)
GF20-1	Steam Nozzle (For DS15P, DS25P & DS25LC)
GFDPO30D22RU	12" 22mm 7/8" Steam Manifold with 9' Condensate Hose
GFDPO450D22RO	17 1/2" 22mm 7/8" Steam Manifold with 9' Condensate Hose
GFCHK7513002	7/8 ID Steam Hose (6') Priced Per Ft. (For DS15P, DS25P, DS25LC & GF5500) (Formerly GF-20:2)
GF25-23	9' Condensate Hose 1/4" ID (Pre Cut 9ft) (For DS15P, DS25P, DS25LC, RS15P & RS25P)
GF7611	Blower Filter Kit (For DS15P, DS25P, DS25LC, RS15P & RS25P)
GP81-60	10' Water Supply Tubing Kit
GF25-50	Wiring Harness including Drain Pump Wiring Kit (For DS15P/DS25)
GF12500	Air Pressure Sensing Switch
GFAP2	AP2 Accessory Conductivity Meter
GFX5	Digital Wi-Fi Humidistat with Furnace Blower Controller
GF25-8	Drain Pump Tank Reservoir & Cover
GF50-27	3/8" Condensate Hose in DPO Kits (Per Ft.)
GFHC201	High Limit Humidistat
GF1312502AXX	Red O-Ring (For DS15P, DS25P & DS25LC)
GF25-12	Steam Cylinder Hose Adapter (For DS15P, DS25P & DS25LC)
GF15-5	Control Module/Board 120V (DS15P & RS15P)
GF15-6	Fill & Tempering Valve/Solenoid 120V (DS15P)
GF15-7	Drain Pump Assembly 120V (For DS15P)
GF25-1	Control Module/Board 230V (For DS25P/DS25LC)
GF15-1	Control Module 110V (For DS15, RS15 & 35)
GF35-1	Control Module 230V (For DS35/RS35)
GF25-3	Fill & Tempering Valve/Solenoid 230V (For DS25P/DS25LC)
GF25-7	Drain Pump Assembly 230V (For DS25P/DS25LC)
DPDS00325	1/2" Quick Connect Tee valve w/ Shut Off
GF35-21	90° Drain Elbow
GF5500-09	Steam Trap Kit

Prices shown are based on carton quantities. 5% surcharge for broken cartons. Our minimum Order Value before H.S.T. is \$250. A surcharge of \$25 on all orders under this minimum will be applied. For Replacement Parts Only, minimum Order Value before H.S.T. is \$50. All prices are subject to change without notice. Any incidental charges incurred will be the responsibility of the buyer, incidents include but are not limited to storing fees, docking charges, etc.

Confidential Distributors List Prices

DEHUMIDIFIERS



- Touch Screen
- Wi-Fi Capabilities
- Filter Change Reminder
- Optional Hanging Kit
- Compact Design

DH75
75 Pints Per 24 Hours
120V & 180CFM
4000 Sq. Ft.

DH100
100 Pints Per 24 Hours
120V & 220CFM
6000 Sq. Ft.

Product Code	Description	Standard Package
GFDH75	Dehumidifier with Capacity of 75 Pints Per Day	1
GFDH100	Dehumidifier with Capacity of 100 Pints Per Day	1
GF7145	DH75 Collar Kit	1
GF7146	DH100 Collar Kit	1
GF6560	Hanging Kits for DH Units	1
GF7375	6.0 Display Control Board Kit (For DH75 & DH100)	1
GF7143	MERV 11 Filter for DH75	1
GF7144	MERV 11 Filter for DH100	1
GF7133	MERV 11 Filter for DH70	1
GF7134	MERV 11 Filter for DH95	1
GF300-0053	Drain Pan for DH70	1
GF6500	Drain Pan for DH75	1
GFDC1	Dehumidistat Control (For DH70 & DH95)	1

Prices shown are based on carton quantities. 5% surcharge for broken cartons.
Our minimum Order Value before H.S.T. is \$250. A surcharge of \$25 on all orders under this minimum will be applied.
For Replacement Parts Only, minimum Order Value before H.S.T. is \$50. All prices are subject to change without notice.
Any incidental charges incurred will be the responsibility of the buyer, incidents include but are not limited to storing fees, docking charges, etc.

Confidential Distributors List Prices

AIR CLEANERS

MAC AIR CLEANERS & REPLACEMENT FILTER MEDIA

Product Code	Description	Standard Package
GFMAC2000-11	20 x 25 Mega MAC Air Cleaner	1
GFMAC1400-11	16 x 25 Mighty MAC Air Cleaner	1
GFMAC1200	16 x 25 Mini MAC Air Cleaner	1
GFMAC2020-11	20 x 20 Mighty MAC Air Cleaner	1
GFMACL	Right Angle MAC Air Cleaner	1
GF4551	20 x 25 x 5 MERV 11 Replacement Filter for MAC2000-11 & MACL GF2025-11 & Perfect Platform	1
GF4541	16 x 25 x 5 MERV 11 Replacement Filter for MAC1400-11 & GF1625-11	1
GF4521	16 x 25 x 3 MERV 8 Replacement Filter for MAC1200	1
GF4556	20 x 20 x 5 MERV 11 Replacement Filter for MAC2020-11	1
GF4547	16 x 25 x 5 MERV 13 Replacement Filter for MAC1400-11 & GF1625-11	1
GF4557	20 x 25 x 5 MERV 13 Replacement Filter for MAC2000-11, MACL, GF2025-11 & Perfect Platform	1



GFMACL
Right Angle Air Cleaner



GFMAC2020-11
MAC Air Cleaner

GENERALAIRE AIR CLEANERS & REPLACEMENT FILTER MEDIA

Product Code	Description	Standard Package
GF1625-11	16 x 25 x5 High Efficiency Air Cleaner	1
GF2025-11	20 x 25 x 5 High Efficiency Air Cleaner	1
GF4551	20 x 25 x 5 MERV 11 Replacement Filter for MAC2000-11 & MACL GF2025-11 & Perfect Platform	1
GF4541	16 x 25 x 5 MERV 11 Replacement Filter for MAC1400-11 & GF1625-11	1
GF4547	16 x 25 x 5 MERV 13 Replacement Filter for MAC1400-11 & GF1625-11	1
GF4557	20 x 25 x 5 MERV 13 Replacement Filter for MAC2000-11, MACL, GF2025-11 & Perfect Platform	1



GF4551 MERV 11 Filter
GF4557 MERV 13 Filter

PERFECT PLATFORMS

Product Code	Description	Standard Package
GFGAFB2832-11	28.5 x 32 Perfect Platform (Good to 2 1/2 Ton Application)	1
GFGAFB2843-11	28.5 x 43 Perfect Platform (Good to 3-5 Ton Application)	1
GF4551	20 x 25 x 5 MERV 11 Replacement Filter for Perfect Platform	1
GF4557	20 x 25 x 5 MERV 13 Replacement Filter for Perfect Platform	1

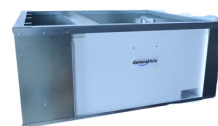

GFGAFB2832-11
Perfect Platform

- For Gas & Electric Furnaces and Air Handlers
- Heavy 22 Gauge Galvanize Sheet Metal
- Fits MERV 11 & MERV 12 Filters

Prices shown are based on carton quantities. 5% surcharge for broken cartons.
Our minimum Order Value before H.S.T. is \$250. A surcharge of \$25 on all orders under this minimum will be applied.
For Replacement Parts Only, minimum Order Value before H.S.T. is \$50. All prices are subject to change without notice.
Any incidental charges incurred will be the responsibility of the buyer, incidents include but are not limited to storing fees, docking charges, etc.

Confidential Distributors List Prices

200/400D Versions
Residential Applications
Ducted into Return Ducting
before Air Cleaner

AIR CLEANERS

HEPA AIR CLEANERS

200/400R Versions
Institutional Applications
(Classrooms, Small Offices,
Board Rooms)



GF400D HEPA Air Cleaner

Product Code	Description	Standard Package
GF200D	Surface or Return Duct Mount HEPA Air Cleaner (200 CFM, Covers 2200 Sq. Ft.)	1
GF200R	Portable Room HEPA Air Cleaner (200 CFM, Covers 2200 Sq. Ft.)	1
GF400D	Surface or Return Duct Mount HEPA Air Cleaner (400 CFM, Covers 4200 Sq. Ft.)	1
GF400R	Portable Room HEPA Air Cleaner (400 CFM, Covers 4200 Sq. Ft.)	1
GF4645	HEPA Filter (For AC500, 200 & 400 Models) (Changed Bi-Annually)	1
GF4646	Pre Filter w/Charcoal (For AC500, 200 & 400) (Changed 3-6 Months)	1

TERSUS AIR CLEANERS

Product Code	Description	Standard Package
GF4572	MERV 13 Replacement Media for T1200	1
GF4562	MERV 13 Replacement Media for T2000	1
GF4567	LED Service Panel	1
SFLT016	Replacement UV Lamp (2 Required)	1

AC MODELS



GFAC22 Air Cleaner

Product Code	Description	Standard Package
GFAC22	High Efficiency Air Cleaner	1
GFAC24	High Efficiency Air Cleaner	1
GFAC12758	20 x 25 x 6 MERV 11 Expandable Media (For AC1 & AC22)	1
GFAC12880	20 X 25 X 6 MERV 11 Expandable Strung Media (For AprilAire 2200 & 2250)	1
GF13156	16 x 27 x 6 MERV 11 Expandable Media (For AC24 & April Aire 2400)	1
GF13415	16 x 27 x 6 MERV 11 Expandable Media for AC4	1

HONEYWELL REPLACEMENT FILTERS

Product Code	Description	Standard Package
GF4366	16 x 25 X 4 MERV 11 Replacement Filter for Honeywell	1
GF4367	20 x 20 X 4 MERV 11 Replacement Filter for Honeywell	1
GF4368	20 x 25 X 4 MERV 11 Replacement Filter for Honeywell	1

Prices shown are based on carton quantities. 5% surcharge for broken cartons.
Our minimum Order Value before H.S.T. is \$250. A surcharge of \$25 on all orders under this minimum will be applied.
For Replacement Parts Only, minimum Order Value before H.S.T. is \$50. All prices are subject to change without notice.
Any incidental charges incurred will be the responsibility of the buyer, incidents include but are not limited to storing fees, docking charges, etc.



Confidential Distributors List Prices

UVC AIR PURIFIERS RESIDENTIAL AIR PURIFIERS

Product Code	Description	Standard Package
NEW GFNBL24	24V UVC Coil Clean Air Purifier (14" Lamp)	1
NEW GFNBL-PRO	24V UVC Coil Clean & Return Duct Air Purifier (14" Lamp)	1
SF2000	Dual Lamp UVC PCO Air Purifier	1
SF2000-230	Dual Lamp UVC PCO Air Purifier with 230/240V Plug In Power Cord	1

RESIDENTIAL REPLACEMENT LAMPS

Product Code	Description	Standard Package
SF1082LR	1 Year Replacement Lamp for GFNBL24/SF2414	1
SF1082LR-TC	2 Year Replacement Lamp for GFNBL24, SF2124C or SF2414	1
SF1082 SIPT	Optional SOS 2 Year Replacement Lamp for GFNBL24, SF2124C or SF2414	1
SF102-959	2 Year Replacement Shatterproof Lamp for SF-2414 Premium or GFNBL-PRO	1
SF1076R	2 Year Replacement Lamp for SF-2018, SF-2000 & SF-2000-230	1
SF1076R-03	Optional SOS 2 Year Replacement Lamp for SF-2018, SF-2000 & SF-2000-230	1
SFLSK36	Replacement Lamp for GUV100A83	1
SFLT50	Replacement Lamp for PCO2450	1

RESIDENTIAL REPLACEMENT BALLASTS

Product Code	Description	Standard Package
SF010303	Replacement Ballast for GFNBL-PRO, SF2414 Premium and SF2124C	1
SF010090	Replacement Ballast for GFNBL24/SF2414	1
SF1060E-R	Replacement Ballast for for SF2018, SF2000, SF2000-230, SF9000(16X25) & SF9000(20X25)	1

OTHER PARTS

Product Code	Description	Standard Package
SF102-998	Indoor Air Quality Test Kit	1

Prices shown are based on carton quantities. 5% surcharge for broken cartons.
Our minimum Order Value before H.S.T. is \$250. A surcharge of \$25 on all orders under this minimum will be applied.
For Replacement Parts Only, minimum Order Value before H.S.T. is \$50. All prices are subject to change without notice.
Any incidental charges incurred will be the responsibility of the buyer, incidents include but are not limited to storing fees, docking charges, etc.



Confidential Distributors List Prices

UVC AIR PURIFIERS

COMMERCIAL AIR PURIFIERS

Product Code	Description	Standard Package
SF2000-2300D	Hardwire UVC PCO Air Purifier (Twin 18" Lamps)	1
SF3018	Hardwire UVC Air Purifier (Single 18" Lamp)	1
SF3024	Hardwire UVC Air Purifier (Single 24" Lamp)	1
SF3032	Hardwire UVC Air Purifier (Single 32" Lamp)	1
SF5009SL	Hardwire UVC PCO Air Purifier (Single 9" Lamp)	1
SF5009DL	Hardwire UVC PCO Air Purifier (Twin 9" Lamps)	1
SF5018SL	Hardwire UVC PCO Air Purifier (Single 18" Lamp)	1
SF5018DL	Hardwire UVC PCO Air Purifier (Twin 18" Lamp)	1
SF5036SL	Hardwire UVC PCO Air Purifier (Single 32" Lamp)	1
SF5036DL	Hardwire UVC PCO Air Purifier (Twin 32" Lamp)	1

COMMERCIAL REPLACEMENT LAMPS

Product Code	Description	Standard Package
SF1076-1RSP	1 Year Replacement Lamp for SF2000-2300D & SF3018	1
SF1097BR-SP	1 Year Replacement Lamp for SF3024	1
SF1081-1RSP	1 Year Replacement Lamp for SF3032	1
SF1068B-R	1 Year Replacement Lamp for SF5009SL & SF5009DL	1
SF1076R	2 Year Replacement Lamp for SF5018SL & SF5018DL	1
SF1081-2R	1 Year Replacement Lamp for SF5036SL & SF5036DL	1

COMMERCIAL REPLACEMENT BALLASTS

Product Code	Description	Standard Package
SF5000B-R	Replacement Ballast for All Commercial UVC Air Purifiers	1
SP2000-2300DBALL	2000-2300D Ballast	1

OTHER PARTS

Product Code	Description	Standard Package
SF5000T	74" Stainless Steel Mounting Track with End Bracket (To Suspend DL/SL UV Models across Ductwork)	1
SF5000C	Track Connectors (Joins Two 5000T's Together)	1

Prices shown are based on carton quantities. 5% surcharge for broken cartons.
 Our minimum Order Value before H.S.T. is \$250. A surcharge of \$25 on all orders under this minimum will be applied.
 For Replacement Parts Only, minimum Order Value before H.S.T. is \$50. All prices are subject to change without notice.
 Any incidental charges incurred will be the responsibility of the buyer, incidents include but are not limited to storing fees, docking charges, etc.

Confidential Distributors List Prices

GF1A25B Oil Filter



FUEL OIL FILTERS

GFRF1 Replacement Cartridge



OIL FILTERS

Product Code	Description	Standard Package
GF1A25B	General Oil Filter with BioGasket (10GPH Firing Rate)	12
GF2A700B	General Oil Filter with BioGasket (25GPH Firing Rate)	12
GF2A17AW 1/2"	1/2" Multi-Purpose Filter	1
GF2A17AW 3/4"	3/4" Multi Purpose Filter	1
GFCGF10K	General Spin On Oil Filter M20 x 1.5mm, Replacement for NozzleGuard NG3500-M	1
GFRBG	Epoxy Coated Spin On Filter with BioGasket	1

REPLACEMENT CARTRIDGES

Product Code	Description	Standard Package
GFK10GF	General Spin On Oil Filter (Cartridge Fits CGF10 or CM10GF)	12
GF1A30P	Wool Felt Blue Bonded Replacement Cartridge (Fits GF1A25B)	36
GF2A710P	Wool Felt Replacement Cartridge (Fits GF2A700B)	24
GFRF1	Rayon Fiber Replacement Cartridge (Fits GF1A25B)	48
GFRF2	Rayon Fiber Replacement Cartridge (Fits GF2A700B)	24
GFG	Epoxy Coated Replacement Cartridge (Fits Spin On Filters)	12
GF2A710SL100T	Replacement Cartridge (Fits GF2A17AW) 100, Stainless Steel Mesh	12
GF2A710SL30T	Replacement Cartridge (Fits GF2A17AW) 30, Stainless Steel Mesh	12
GF2A710SL60T	Replacement Cartridge (Fits GF2A17AW) 60, Stainless Steel Mesh	12

FILTER BOWL REPAIR KIT

Product Code	Description	Standard Package
GF10542	Filter Bowl Repair Kit for 1A25B/77	12
GF10821	Filter Bowl Repair Kit for 2A700/99	12

Prices shown are based on carton quantities. 5% surcharge for broken cartons.
Our minimum Order Value before H.S.T. is \$250. A surcharge of \$25 on all orders under this minimum will be applied.
For Replacement Parts Only, minimum Order Value before H.S.T. is \$50. All prices are subject to change without notice.
Any incidental charges incurred will be the responsibility of the buyer, incidents include but are not limited to storing fees, docking charges, etc.

Confidential Distributors List Prices



OIL ACCESSORIES

Product Code	Description	Standard Package
GFCGFHEAD20	Head Only for CGF10K & GFCM10GF	1
GF100UL	44" ULC Approved Tank Gauge	25
GP100BR	Top Plastic for GF100UL	1
GP100LN	Rubber Gasket for GF100UL	1
GF100GPU	Metal Cover Tank Gauge Protector	1
GF124	1/2" x 3/8" Tank Valve	12
GF130	Oil Tank Valve with 90° Ball Valve	1
GF125Z	1 1/4" Zinc Vent Cap	120
GF200Z	2" Zinc Fill Cap	120
GF201	2" Threaded Fill Cap	150
GF200VA	2" Aluminum Vent Cap	1
GF202	2" Locking Fill Cap	100
GF2126	2" x 1 1/4" x 1 1/4" Tank Whistle	15
GFB	Bracket for Spin On Filter Head	1
GFFRI	Fuel Restriction Indicator	1
GFGK3	Gasket for 2A17AW (BioGasket)	1
GF11V	1" Aluminum Spin On Head	1
GFTAP90BVULC	Tank Accessory Kit with 90° Ball Valve Bottom Outlet	25
GFTAPECO	Tank Accessory Kit with MTCO Valve End Outlet	25
GFTAPECO-4	Tank Accessory Kit with No Tank Valve	1
GF3000	EZ Change Filter Draining System	1
GFBG51A	BioGasket for 1A25B/77	5
GFBG52A	BioGasket for 2A700	5

Prices shown are based on carton quantities. 5% surcharge for broken cartons.
 Our minimum Order Value before H.S.T. is \$250. A surcharge of \$25 on all orders under this minimum will be applied.
 For Replacement Parts Only, minimum Order Value before H.S.T. is \$50. All prices are subject to change without notice.
 Any incidental charges incurred will be the responsibility of the buyer, incidents include but are not limited to storing fees, docking charges, etc.

Confidential Distributors List Prices



OIL FILTERS

RESIDENTIAL OIL FILTERS

Product Code	Description	Standard Package
GFR	Gar-Ber Replacement Spin On Cartridge	12
GF11V-R	Gar-Ber Spin On Fuel Oil Filter	12
GF11BV-R	Gar-Ber Spin On Fuel Oil Filter with Bracket	12
GF11BV-RK	Gar-Ber Oil Filter with Restriction Indicator Gauge and Bracket	12

COMMERCIAL OIL FILTERS

Product Code	Description	Standard Package
GFM	Gar-Ber Replacement Spin On Cartridge	12
GF11BV-M	Gar-Ber Spin On Fuel Oil Filter with Bracket	12
GF11BV-MK	Gar-Ber Oil Filter with Restriction Indicator Gauge and Bracket	12

WATER BLOCK FILTERS

Product Code	Description	Standard Package
GFR2000	Replcmt Spin On Water Block Cartridge	12

GFR Replacement Spin On Cartridge



GF11V-R Fuel Oil Filter



Prices shown are based on carton quantities. 5% surcharge for broken cartons.
Our minimum Order Value before H.S.T. is \$250. A surcharge of \$25 on all orders under this minimum will be applied.
For Replacement Parts Only, minimum Order Value before H.S.T. is \$50. All prices are subject to change without notice.
Any incidental charges incurred will be the responsibility of the buyer, incidents include but are not limited to storing fees, docking charges, etc.



Confidential Distributors List Prices



TJERNLUND PRODUCTS, INC.

PRESSURE SWITCHES & APPLIANCE INTERLOCK PRODUCTS

Product Code	Description	Standard Package
TJPS-1503	Duct Air Stat Positive Pressure Air Switch	1
TJPS-2501	Pressure Stat Pos/Neg Pressure Air Switch	1
TJUC1	Universal Control	1
TJMAC1E	Appliance Interlock 115/24V (For Use with UC1)	1
TJMAC4E	4 Appliance Interlock 115/24V (For Use with UC1)	1

UNDERAIRE CRAWL SPACE VENTILATORS

Product Code	Description	Standard Package
TJV1	Crawl Space Ventilator (110 CFM)	1
TJV1D	Crawl Space Vent with Dehumidistat (110 CFM)	1
TJV2D	Crawl Space Vent with Dehumidistat (220 CFM)	1
TJDH10	Dehumidistat	1
TJDH2P	Dehumidistat with Two 115 Outlets for CS1 & CS2	1

NO CLOG DRYER DUCT BOOSTER

Product Code	Description	Standard Package
TJLB2	No Clog Dryer Duct Booster (Res 160 CFM)	1

WATER HEATER VENT SYSTEM MILLIVOLT CONTROLS & SPILLAGE SWITCH KIT

Product Code	Description	Standard Package
TJWHKE	Millivolt Water Heater Interlock (For use with UC1)	1

SIDE WALL RADON MITIGATION SYSTEM

Product Code	Description	Standard Package
TJRMS160	Radon Vac Includes Stainless Steel Vent Hood	1
TJRA1	Radon Fan Failure Alarm	1

Prices shown are based on carton quantities. 5% surcharge for broken cartons.
 Our minimum Order Value before H.S.T. is \$250. A surcharge of \$25 on all orders under this minimum will be applied.
 For Replacement Parts Only, minimum Order Value before H.S.T. is \$50. All prices are subject to change without notice.
 Any incidental charges incurred will be the responsibility of the buyer, incidents include but are not limited to storing fees, docking charges, etc.

Phone: 416-757-3691 | Toll: 888-216-9184 | Email: sales@generalaire.ca



Confidential Distributors List Prices



TJERNLUND PRODUCTS, INC.

ROOF TOP INDUCERS

Product Code	Description	Standard Package
TJRT750	Rooftop Inducer w/PSA-1 for Gas & Oil (Commercial)	1
TJRT750H	Rooftop Inducer with Speed Control for Solid Fuel Fireplaces and Ovens	1
TJRTS8	Rooftop Stand for RT750	1
TJDH750	Discharge Hood with Damper RT750 Series	1
TJRT1500	Rooftop Inducer w/PSA-1 for Gas & Oil (Commercial)	1
TJRT1500H	Rooftop Inducer with Speed Control for Solid Fuel Fireplaces and Ovens	1
TJRTS12	Rooftop Stand for RT1500	1
TJDH1500	Discharge Hood with Damper RT1500 Series	1
TJUCRT	Universal Control with Speed Control	1
TJCOP2	Constant Operating Pressure Control (Optional) *Not Included with Models, Must be Ordered Separately*	1

BALANCING BAFFLES

Product Code	Description	Standard Package
TJABD4	4" Stainless Steel Balancing Baffle	1
TJABD6	6" Stainless Steel Balancing Baffle	1
TJABD8	8" Stainless Steel Balancing Baffle	1
TJABD10	10" Stainless Steel Balancing Baffle	1

AIRSHARE VENTILATORS

Product Code	Description	Standard Package
TJAS1	Airshare Room to Room Ventilator-Hard Wired	1
TJASLL	Airshare Level to Level Transfer Fan	1
TJSWS	Airshare Wireless Wall Switch Control	1
TJSWT	Airshare Wireless Thermostat Control Heat Only	1

XCHANGER BASEMENT FAN

Product Code	Description	Standard Package
TJX2D	XChanger Basement Fan	1
TJDT2-6	Dual 6" Duct Connectors	1
TJSCP	Plug-In Speed Control	1

Prices shown are based on carton quantities. 5% surcharge for broken cartons.
Our minimum Order Value before H.S.T. is \$250. A surcharge of \$25 on all orders under this minimum will be applied.
For Replacement Parts Only, minimum Order Value before H.S.T. is \$50. All prices are subject to change without notice.
Any incidental charges incurred will be the responsibility of the buyer, incidents include but are not limited to storing fees, docking charges, etc.



Confidential Distributors List Prices



TJERNLUND PRODUCTS, INC.

IN LINE DRAFT INDUCER PARTS

AD-1

Product Code	Description	Standard Package
TJAD-1	Auto Draft Inducer for Wood & Coal Stoves	1
TJ950-8000	Housing Kit	1
TJ950-3012	Wheel Kit	1
TJ950-3022C	Motor Kit	1
TJ950-4030	Speed Control Kit	1

DJ-3

Product Code	Description	Standard Package
TJDJ-3	Inducer Std 115V/60HZ/1550RPM/35W Includes PS1505 CSA Approved	1
TJ950-3000	Housing Kit	1
TJ950-3010	Wheel Kit	1
TJ950-3020C	Motor Kit	1

D-3

Product Code	Description	Standard Package
TJD3	Inducer Std 115V/60HZ/1550RPM/74W Includes PS1505 CSA Approved	1
TJ950-3002	Housing Kit	1
TJ950-3012	Wheel Kit	1
TJ950-3022C	Motor Kit	1

I

Product Code	Description	Standard Package
TJI	Inducer Std 115V/60HZ/1725RPM/¼HP/5.4Amps	1
TJ950-4000	Housing Kit	1
TJ950-4010	Wheel Kit (Also for Discontinued I-R)	1
TJ950-4020	Can 1/3 HP Motor Kit (Also for Discontinued I-R)	1
TJ950-4025	Shaft Extension Kit	1

Prices shown are based on carton quantities. 5% surcharge for broken cartons.
 Our minimum Order Value before H.S.T. is \$250. A surcharge of \$25 on all orders under this minimum will be applied.
 For Replacement Parts Only, minimum Order Value before H.S.T. is \$50. All prices are subject to change without notice.
 Any incidental charges incurred will be the responsibility of the buyer, incidents include but are not limited to storing fees, docking charges, etc.

Confidential Distributors List Prices



TJERNLUND PRODUCTS, INC.

IN LINE DRAFT INDUCER PARTS

IL

Product Code	Description	Standard Package
TJIL	Inducer Std 115V/60HZ/1725RPM/¼HP/5.4Amps	1
TJ950-5000	Housing Kit	1
TJ950-5010	Wheel Kit (Also for Discontinued IL-R)	1
TJ950-4020	Can 1/4HP Motor Kit	1
TJ950-4025	Shaft Extension Kit	1

HD

Product Code	Description	Standard Package
TJHD-ROUND	Inducer Std 230 or 460V/60HZ/1725RPM/2HP/6.4Amps Flat or Round	1
TJ950-0117	Belt Kit	1
TJ950-0106	Motor Sheave Kit	1
TJ950-0104	Shaft Sheave Kit	1
TJ950-0151	2 HP Motor Kit	1
TJ950-0114	Drive Shaft Kit	1
TJ950-0108	Bearing Kit	1
TJ950-1074	Wheel Kit	1

XL

Product Code	Description	Standard Package
TJXL	Inducer Std 115V/60HZ/1725RPM/¾HP/10.8Amps	1
TJ950-6010	Wheel Kit (XL-R is Discontinued)	1
TJ950-0140	Can 3/4 HP Motor Kit (Also for Discontinued XL-R)	1

ADDITIONAL PARTS

Product Code	Description	Standard Package
TJPS-1505	Fan Proving Switch	1

Prices shown are based on carton quantities. 5% surcharge for broken cartons.
Our minimum Order Value before H.S.T. is \$250. A surcharge of \$25 on all orders under this minimum will be applied.
For Replacement Parts Only, minimum Order Value before H.S.T. is \$50. All prices are subject to change without notice.
Any incidental charges incurred will be the responsibility of the buyer, incidents include but are not limited to storing fees, docking charges, etc.



Confidential Distributors List Prices



TJERNLUND PRODUCTS, INC.

SIDE WALL VENT SYSTEMS PARTS

GPAK-JT (GPAK-J & GPAK JT DISCONTINUED)

Product Code	Description	Standard Package
TJHSJ	Power Venter 24/115V Relay Includes UCI Control	1
TJ950-1020C	Motor Kit	1
TJ950-1010	Wheel Kit	1
TJ950-1030	Fan Prover with Sensing Tube Kit	1
TJ950-1067	1-10 Minute Adjustable Timer	1
TJ950-1040	24V/115V Vac Relay Kit	1

GPAK-IT (GPAK-I & IT DISCONTINUED)

Product Code	Description	Standard Package
TJHS1	Power Venter 24/115V Relay Includes UCI Control	1
TJ950-1020C	Motor Kit	1
TJ950-1011	Wheel Kit	1
TJ950-1030	Fan Prover with Sensing Tube Kit	1
TJ950-1067	1-10 Minute Adjustable Timer	1
TJ950-1040	24V/115V Vac Relay Kit	1

SS1 (SS1C DISCONTINUED)

Product Code	Description	Standard Package
TJSS1	Power Venter Side Shot Includes UC1 Control	1
TJ950-8804	UC1 Control Circuit Board	1
TJ950-1067	Adjustable 1-10 Min Timer/Relay (Pre UC1)	1
TJ950-0650	Fan Prover Kit	1
TJ950-0680	Terminus Switch	1
TJ950-0625	Motor/Wheel Assembly 5/8" Bore	1
TJ950-0635	Wheel 5/8" Bore	1
TJ950-0001	Sensing Tube with Inlet Collar	1
TJ950-0011	Terminus Cone with Brackets	1
TJ950-0641	Spring Ring Assembly	1

Prices shown are based on carton quantities. 5% surcharge for broken cartons.
 Our minimum Order Value before H.S.T. is \$250. A surcharge of \$25 on all orders under this minimum will be applied.
 For Replacement Parts Only, minimum Order Value before H.S.T. is \$50. All prices are subject to change without notice.
 Any incidental charges incurred will be the responsibility of the buyer, incidents include but are not limited to storing fees, docking charges, etc.

Phone: 416-757-3691 | Toll: 888-216-9184 | Email: sales@generalaire.ca



Confidential Distributors List Prices



TJERNLUND PRODUCTS, INC.

SIDE WALL VENT SYSTEMS PARTS

SS2 (SS2-G DISCONTINUED)

Product Code	Description	Standard Package
TJ950-8804	UC1 Control Circuit Board	1
TJ950-1067	Adjustable 1-10 Min Timer/Relay (Pre UC1)	1
TJ950-0016	Prover (Old Style External J Box Mount)	1
TJ950-0018	High Limit Switch	1
TJ950-0015	Motor Kit	1
TJ950-0017	Impeller (Stainless)	1
TJ950-0019	Venter Housing (Stainless)	1
TJ950-0020	Cooling Fan	1
TJ950-0099	Terminus Cabinet	1
TJ950-0029	Prover (External J Box Mount Since 07/02)	1

VP-2 (DISCONTINUED)

Product Code	Description	Standard Package
TJ950-2000	Housing/Wheel Kit	1
TJ950-2020	Motor Kit	1
TJ950-1067	Adjustable 1-10 Min Timer/Relay (Pre UC1)	1
TJ950-2030	24V/115V Transformer	1
TJ950-2050	6' Two Wire Spill Switch Cable (Old Style)	1
TJ950-2060	25' Three Wire Control Cable	1
TJ950-2070	Two 200° F Spill Switches (Old Style)	1
TJ950-2064	185° F Linear Limit Switch (New Style)	1
TJ950-2080	Gas Pressure Switch	1
TJ950-1070	Vibration Isolation Kit	1

SIDE WALL VENT HOODS

Product Code	Description	Standard Package
TJVH-1-3	3" Vent Hood with Casting	1
TJVH-1-4	4" Vent Hood with Casting	1
TJVH-1-6	6" Vent Hood	1
TJVH-1-8	8" Vent Hood	1
TJVH-1-10	10" Vent Hood	1

Prices shown are based on carton quantities. 5% surcharge for broken cartons.
 Our minimum Order Value before H.S.T. is \$250. A surcharge of \$25 on all orders under this minimum will be applied.
 For Replacement Parts Only, minimum Order Value before H.S.T. is \$50. All prices are subject to change without notice.
 Any incidental charges incurred will be the responsibility of the buyer, incidents include but are not limited to storing fees, docking charges, etc.

Confidential Distributors List Prices



TJERNLUND PRODUCTS, INC.

POWER VENTER PARTS

HSJ (INCLUDES UC1 CONTROL) HSUL-J
DISCONTINUED MODELS: HSUL-J, HST-J & HS115-J

Product Code	Description	Standard Package
TJHSJ	Power Venter 24/115V Relay Includes UCI Control	1
TJ950-1020C	Motor Kit	1
TJ950-1010	Wheel Kit	1
TJ950-1030	Fan Prover with Sensing Tube Kit	1
TJ950-8804	UC1 Circuit Board (Only for HSJ)	1
TJ950-1040	Relay Kit (Only for HSUL-J)	1
TJ950-1067	Adjustable 1-10 Min Timer/Relay (Pre UC1) (Only for HST-J)	1

HS1 (INCLUDES UC1 CONTROL)
DISCONTINUED MODELS: HSUL-1, HST-1 & HST115-1

Product Code	Description	Standard Package
TJHS1	Power Venter 24/115V Relay Includes UCI Control	1
TJ950-1020C	Motor Kit	1
TJ950-1011	Wheel Kit	1
TJ950-1030	Fan Prover with Sensing Tube Kit	1
TJ950-8804	UC1 Circuit Board (Only for HS1)	1
TJ950-1040	Relay Kit (Only for HSUL-1)	1
TJ950-1067	Adjustable 1-10 Min Timer/Relay (Pre UC1) (Only for HST-1)	1

HS2 (INCLUDES UC1 CONTROL)
DISCONTINUED MODELS: HSUL-2, HST-2 & HS115-2

Product Code	Description	Standard Package
TJHS2	Power Venter 24/115V Relay Includes UCI Control	1
TJ950-1021C	Motor Kit with Wheel 3/8" Bore	1
TJ950-1012	Wheel Kit 3/8" Bore	1
TJ950-1031	Fan Prover with Sensing Tube Kit	1
TJ950-8804	UC1 Circuit Board (Only for HS2)	1
TJ950-1040	Relay Kit (Only for HSUL-2)	1
TJ950-1067	Adjustable 1-10 Min Timer/Relay (Pre UC1) (Only for HST-2 & HS115-2)	1

Prices shown are based on carton quantities. 5% surcharge for broken cartons.
Our minimum Order Value before H.S.T. is \$250. A surcharge of \$25 on all orders under this minimum will be applied.
For Replacement Parts Only, minimum Order Value before H.S.T. is \$50. All prices are subject to change without notice.
Any incidental charges incurred will be the responsibility of the buyer, incidents include but are not limited to storing fees, docking charges, etc.



Confidential Distributors List Prices



TJERNLUND PRODUCTS, INC.

COMMERCIAL POWER VENTER PARTS

HS3 (INCLUDES UC1 CONTROL)

Product Code	Description	Standard Package
TJHS3	Commercial Power Venter with UCI Control for Gas	1
TJ950-1022	1/4 HP Motor Kit	1
TJ950-1013	Wheel Kit	1
TJ950-1032	Fan Prover Kit	1
TJ950-1014	Housing	1
TJ950-8804	UC1 Circuit Board	1
TJ950-1040	Isolation or Motor Relay (Only Used for HS3 Models Prior to the UC1 Change Over Date 09/02)	1
TJ950-1046	Housing Sensing Tube Kit	1

HS4 (INCLUDES UC1 CONTROL)

Product Code	Description	Standard Package
TJHS4	Commercial Power Venter with UCI Control for Gas	1
TJ950-0131C	1/3 HP Motor Kit	1
TJ950-1013	Wheel Kit	1
TJ950-0010	HS4 Shaft Extension	1
TJ950-1007	Fan Prover Kit	1
TJ950-1008	Housing	1
TJ950-8804	UC1 Circuit Board	1
TJ950-1040	Isolation or Motor Relay	1

HS5 (INCLUDES UC1 CONTROL)

Product Code	Description	Standard Package
TJHS5	Commercial Power Venter with UCI Control for Gas	1
TJ950-1017	1 HP Motor Kit	1
TJ950-1015	Wheel Kit	1
TJ950-1007	Fan Prover Kit	1
TJ950-1018	Housing	1
TJ950-8804	UC1 Circuit Board	1
TJ950-1040	Isolation or Motor Relay	1

SIDE WALL VENT SYSTEM

TJVP2F	Side Wall Vent System (For Water Heaters 60,000BTU or Less)	1
TJVP3F	Side Wall Vent System (For Water Heaters 60,000BTU to 120,000BTU)	1

Prices shown are based on carton quantities. 5% surcharge for broken cartons.
 Our minimum Order Value before H.S.T. is \$250. A surcharge of \$25 on all orders under this minimum will be applied.
 For Replacement Parts Only, minimum Order Value before H.S.T. is \$50. All prices are subject to change without notice.
 Any incidental charges incurred will be the responsibility of the buyer, incidents include but are not limited to storing fees, docking charges, etc.

Confidential Distributors List Prices



TJERNLUND PRODUCTS, INC.

DUCT BOOSTERS

TJ-DB-2

Product Code	Description	Standard Package
TJDB2	Duct Booster 1150RPM/70HP/200CFM Cap 5-8" Duct CSA Approved	1
TJ950-7010	Wheel Kit	1
TJ950-7025C	Motor Kit	1

TJ-EF-6

Product Code	Description	Standard Package
TJEF-6	Duct Fan for 6" Flex or Metal Duct	1

TJ-EF-8

Product Code	Description	Standard Package
TJEF-8	Duct Fan for 8" Flex or Metal Duct	1
TJ950-0428	Motor Kit	1
TJ950-0418	Impeller Kit	1

TH-EF-10

Product Code	Description	Standard Package
TJEF-10	IDDF for 10" Duct	1
TJ950-0425	Motor Kit	1
TJ950-0419	Impeller Kit	1

TJ-EF-12

Product Code	Description	Standard Package
TJEF-12	IDDF for 12" Duct	1
TJ950-0424	Motor Kit	1
TJ950-0420	Impeller Kit	1

TJ-EF-14

Product Code	Description	Standard Package
TJEF-14	IDDF for 14" Duct	1
TJ950-0423	Motor Kit	1
TJ950-0421	Impeller Kit	1

Prices shown are based on carton quantities. 5% surcharge for broken cartons.
Our minimum Order Value before H.S.T. is \$250. A surcharge of \$25 on all orders under this minimum will be applied.
For Replacement Parts Only, minimum Order Value before H.S.T. is \$50. All prices are subject to change without notice.
Any incidental charges incurred will be the responsibility of the buyer, incidents include but are not limited to storing fees, docking charges, etc.



Confidential Distributors List Prices



TJERNLUND PRODUCTS, INC.

ACCESSORY CONTROL PARTS

TJ-UC1

Product Code	Description	Standard Package
TJ950-8804	UC1 Circuit Board	1

TJ-WHK-2

Product Code	Description	Standard Package
TJ950-1067	Adjustable 1-10 Min Timer/Relay (Pre UC1)	1
TJ950-2030	24V/115V Transformer	1
TJ950-2050	6' Two Wire Spill Switch Cable (Old Style)	1
TJ950-2060	25' Three Wire Control Cable	1
TJ950-2070	Two 200° F Spill Switches (Old Style)	1
TJ950-2064	185° F Linear Limit Switch (New Style)	1
TJ950-2080	Gas Pressure Switch	1

TJ-WHK-1

Product Code	Description	Standard Package
TJ950-2075	One 200° F Spill Switches (Old Style)	1
TJ950-2064	185° F Linear Limit Switch (New Style)	1
TJ950-0501	Gas Pressure Switch	1
TJ950-0470	Thermocouple Junction Adapter	1

Prices shown are based on carton quantities. 5% surcharge for broken cartons.
 Our minimum Order Value before H.S.T. is \$250. A surcharge of \$25 on all orders under this minimum will be applied.
 For Replacement Parts Only, minimum Order Value before H.S.T. is \$50. All prices are subject to change without notice.
 Any incidental charges incurred will be the responsibility of the buyer, incidents include but are not limited to storing fees, docking charges, etc.

Confidential Distributors List Prices



SOOTMASTERS

641M

652M

Product Code	Description	Standard Package
MT652M	5 Gallon 1HP Motor	1
MT4465	Replacement Bags for Model 652M	1

SOOTMASTER PARTS

Product Code	Description	Standard Package
MTCV46A	Clog Proof Dacron Bag for 14" Dia Vacuum	1
MTCV47	Clog Proof Dacron Bag for 16" Dia Vacuum	1
MT2T1	Tie Cord for Standard or Deluxe Open Top Bags	1
MT7HB-3	Rubber Stretch Hose 6-16' c/w Rubber Cuffs	1
MT7HB-7	10' White Duck - Rubber Lined Hose	1
MT7HB-9	10' Black Canvas - Rubber Lined Hose	1
MT7HB-17E	10' Vinyl Hose with Molded Vinyl Cuffs	1
MT7HB-21AB-10	10' Crushproof Vinyl Hose 1 ½" ID	1

**641M
DRY ONLY**



**652M
DRY ONLY**



Prices shown are based on carton quantities. 5% surcharge for broken cartons.
 Our minimum Order Value before H.S.T. is \$250. A surcharge of \$25 on all orders under this minimum will be applied.
 For Replacement Parts Only, minimum Order Value before H.S.T. is \$50. All prices are subject to change without notice.
 Any incidental charges incurred will be the responsibility of the buyer, incidents include but are not limited to storing fees, docking charges, etc.



Confidential Distributors List Prices

MASTERCRAFT
PROFESSIONAL PRODUCTS FOR A CLEANER ENVIRONMENT

MORE SOOTMASTERS PARTS

Product Code	Description	Standard Package
MT100-2	5' Aluminum Double Bend Curved Wand	1
MT103-1	15" Metal Crevice Tool	1
MT103-2	27" Metal Crevice Tool	1
MT103-5	11" Plastic Crevice Tool	1
MT103-7	6' x 1 ½" OD Flexible Metal Hose	1
MT103-9	Blower Nozzle	1
MT103-10	6' x 1" OD Flexible Metal Hose	1
MT103-11	4' x 7/8" Flex Metal Hose	1
MT104-11	6" Utility Nozzle Tapered Fit	1
MT105-1	Metal Connector Adjoins Two 1 ½" ID Hoses	1
MT106-1	12" Wide Mouth Gulper Nozzle	1
MT1015	Filter Frame Assembly 16" Diameter	1
MT1016	Filter Frame Assembly 14" Diameter	1
MT1017	Filter Frame Assembly 14" Diameter Pancake Style	1
MT1126	Cloth Filter & Gasket 14" Diameter Pancake Style	1
MT1127	Cloth Filter & Gasket 14" Diameter	1
MT1128	Cloth Filter & Gasket 16" Diameter	1
MT1203	Replacement Toggle Switch	1
MT12541	2 ½" Diameter Non Marking Swivel Caster	1
MT1455	1 ½" Swivel Connector for Vacuum	1
MT1668	Rubber Sealing Gasket for 1455	1
MT1700	Hose Cage for 14" Diameter Cans	1
MT2797	Replacement Blower Outlet	1
MT4464S	Paper Filter Bags 5 Pack for Model 641M	5
MT4465	Paper Filter Bags 5 Pack for Model 654M & 653M	5
MT4562PL	Totally Enclosed 16" Bags 5 Pack for Models 654M/661M	5
MT5041	1 HP Air Cooled Motor	1
MTDA1515	Drum Adapter 2 ¼ HP Wet/Dry	1
MT5520Z220	Canister Assembly for 641M Vacuum	1
MT5522Z202	Head Assembly for 641M Vacuum	1
MT5521Z201	Dome Assembly for 641M Vacuum	1
MT410SSDAF	Back Pack HEPA Vacuum 1 ¼ HP	1
MT261416	4' x 7/8" Flexible Metal Hose	1

Prices shown are based on carton quantities. 5% surcharge for broken cartons.
Our minimum Order Value before H.S.T. is \$250. A surcharge of \$25 on all orders under this minimum will be applied.
For Replacement Parts Only, minimum Order Value before H.S.T. is \$50. All prices are subject to change without notice.
Any incidental charges incurred will be the responsibility of the buyer, incidents include but are not limited to storing fees, docking charges, etc.

Phone: 416-757-3691 | Toll: 888-216-9184 | Email: sales@generalaire.ca



Confidential Distributors List Prices



SUPERIOR SMOKE GENERATORS

Product Code	Description	Standard Package
SU1A	30 Second /4000 Cubic Feet 1 ½” x 1 Smoke Generator	12
SU2B	1 Minute / 8000 Cubic Feet 1 ½” x 2” Smoke Generator	12
SU3C	2 – 3 Minute / 40,000 Cubic Feet 1 ½” x 6” Smoke Generator	12



SU2B Smoke Generator

Prices shown are based on carton quantities. 5% surcharge for broken cartons.
Our minimum Order Value before H.S.T. is \$250. A surcharge of \$25 on all orders under this minimum will be applied.
For Replacement Parts Only, minimum Order Value before H.S.T. is \$50. All prices are subject to change without notice.
Any incidental charges incurred will be the responsibility of the buyer, incidents include but are not limited to storing fees, docking charges, etc.



Standard Terms and Conditions

PRICING

All standard pricing is based on our current Distributor Price List Schedules, which is updated & distributed as required. Every effort is made to provide a minimum 30-day notification of a price change, however CGF reserves the right to change prices without notification.

SEASONAL STOCKING PROMOTIONS: CGF periodically issues stocking programs at special discounted net prices and terms. Refer to the program for specific details.

SPECIAL PRICE QUOTATIONS: If special price quotes are issued by CGF, a valid quote number must be shown on all related purchase orders. A valid quote will show validation date and expiry date, as well as part number, quantities, and terms. Quotes must be written and signed by a Canadian General Filters Ltd signing officer.

SURCHARGE, BROKEN CARTONS: A 5% surcharge will be charged if the quantity of goods ordered result in a broken carton. This surcharge is enforced in all circumstances, regardless whether the product pricing is regular, part of a seasonal promotion or specifically quoted.

ORDERING

Our minimum Order Value before H.S.T. is \$250. A surcharge of \$25 on all orders under this minimum will be applied.

For Replacement Parts Only, minimum Order Value before H.S.T. is \$50.

Any incidental charges incurred will be the responsibility of the buyer, incidents include but are not limited to storing fees, docking charges, etc.

Customer Service is available by phone from 8:00am to 4:30pm EST Monday to Friday at 416-757-3691 or toll free at 1-888-216-9184. To minimize possible errors or miscommunication, we require that all purchase orders be faxed to CGF Products at 416-757-4687 or emailed to sales@generalaire.ca

ACKNOWLEDGEMENTS: All orders will be acknowledged by fax or email. It is the customers responsibility to advise of any changes or adjustments to the order as acknowledged.

FREIGHT TERMS

Unless otherwise specified, all shipments are FOB CGF's Midwest warehouse.

PREPAID FREIGHT: Filter cabinets & Filter media do not qualify for pre-paid freight! To qualify for Prepaid Freight, all orders for products that qualify must total or exceed \$5,000.00 net (before taxes). To be more specific, the products not eligible for Prepaid Freight are: Air Filters, Air Cleaner Cabinets & Perfect Platforms. Customers can continue to submit orders inclusive of the excluded items and CGF staff will remove the non-eligible items & create a separate release. CGF will supply the information required for customers to organize their own transportation for non-eligible items. CGF offers a 2% freight allowance on the bottom of the invoice for non-eligible pre-paid products.

CGF will ONLY pay base freight, and not accessorial with respect to our \$5000 Prepaid Freight.

SPECIFIC LIST OF INELIGIBLE PREPAID ITEMS:

GFMAC2000-11, GFMAC1400-11, GFMAC1200, GFMAC2020-11, GFMACL, GF1625-11, GF2025-11, GFGAFB2832-11, GFGAFB2843-11, GF4551, GF4541, GF4521, GF4556, GF4557, GF4366, GF4367, GF4368 and 6" furnace base models SF1728G, SF2128G, SF2428G



Standard Terms and Conditions

CREDIT TERMS

Standard credit terms for approved accounts are 1 ½ % 10, net 30 days.

DISCOUNTS APPLIED: Cash discounts for early payment are to be taken on the invoiced product value excluding freight and taxes

UNEARNED DISCOUNTS: To be eligible for cash discounts, accounts must be current and payment must be received by CGF Ltd no later than the discount due date. Unearned discounts taken will not be honored by CGF.

OUTSTANDING ACCOUNTS: If an account is past due, shipment of new orders will be held. Upon receipt of payment, shipments will be released accordingly.

CREDIT NOTES: With the exception of early payment discounts, customers are not entitled to make any deductions from payments without CGF authorization in the form of a Credit Note. We reserve the right to inspect and assess the product to determine applicable re-stocking charges, before issuing Credit Notes.

Goods returned for credit will be subject to a minimum restocking charge of 35%.

WARRANTY

Canadian General Filters Limited will warranty items upon review of our warranty coverage chart and purchase invoice.

The warranty covers product defects in materials and workmanship only. Defective parts will be repaired or replaced at the manufacturer's discretion without charge. Costs involved in the removal, re-installation and/or transportation of the defective part is not covered by warranty.

There are no express warranties other than those set forth above, the implied warranties of merchant ability and fitness for a particular purpose are limited in duration to one year. The manufacturer assumes no liability in connection with the installation or use of the products except as stated in this limited warranty.

The manufacturer assumes no responsibility and will not be held liable for incidental or consequential damages.

This warranty does not cover labour charges, failure due to abuse, improper use, normal wear and tear or consumables.

RETURN OF GOODS POLICY

ALL GOODS RETURNED: Whatever the reason, must have a Returned Goods Authorization (RGA) Number issued by our Customer Service Department, and must be returned within 14 days of issue of this RGA number. RGA must be clearly displayed on outside of package. All returned goods will be shipped prepaid unless otherwise approved and the paperwork must indicate the RGA number.

Goods returned for credit must be in the original packaging and must be in new saleable condition. All goods returned for credit are subject to inspection and acceptance by CGF and are subject to a minimum restocking charge of 35%. Additional charges may apply. CGF reserves the right to refuse returned goods due to age and condition of the products.

DAMAGED GOODS

If the shipment is prepaid, Canadian General Filters is responsible for carrier damages/shortages. An investigation with the transport company is then initiated

Non-prepaid or pick up shipments are not the responsibility of Canadian General Filters, customer must deal with the transport company directly for any damages/shortages.

Title to goods shipped via common carrier collect passes to the consignee upon acceptance of the shipment by the carrier. All claims for loss, due to shortage or damage, must be made to the Transportation company. Upon discovery of concealed damage, or shortage, notify the carrier agent at once and request an inspection.

All shortages must be reported within 24 – 48 hours of receipt of shipment for credits to be honored

Prices shown are based on carton quantities. 5% surcharge for broken cartons.
Our minimum Order Value before H.S.T. is \$250. A surcharge of \$25 on all orders under this minimum will be applied.
For Replacement Parts Only, minimum Order Value before H.S.T. is \$50. All prices are subject to change without notice.
Any incidental charges incurred will be the responsibility of the buyer, incidents include but are not limited to storing fees, docking charges, etc.

Phone: 416-757-3691 | Toll: 888-216-9184 | Email: sales@generalaire.ca